

**PRINT & GO**

**PRACTICE PLANS & DRILLS**

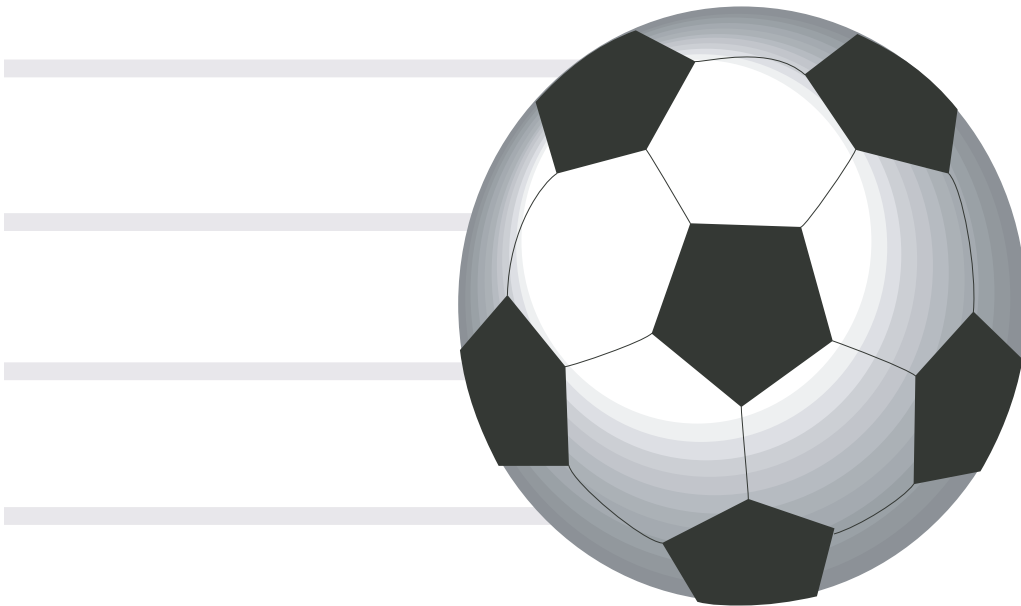

**YOUTH COMPETITIVE  
SENIOR AMATEUR**

**ADV. SKILLS & TACTICS**

## TABLE OF CONTENTS

Acknowledgement	4
Introduction	5
Our Philosophy	6
Usage Recommendations	7
Practices Summary Matrix	8
Season Practice Sequences	9
Print & Go Practices	10
• # 1 Fast Break Attack #1	11
• # 2 Flank Attack, Scoring	12
• # 3 Defending	13
• # 4 Passing, Anticipation, Transition	14
• # 5 Scoring, Transition Play	15
• # 6 Ball Control, Flank Attack	16
• # 7 Scoring Goals, Flank Attack	17
• # 8 Crossing Balls, Scoring	18
• # 9 Defending	19
• #10 Scoring, Flank Attack #2	20
PracticeBuilder Warm-Ups	21
• # 1 Passing, Headers, 1v1	22
• # 2 Dribbling, 1v1	23
• # 3 Dribbling, agility	24
• # 4 Anticipation, Passing	25
• # 5 Dribbling & Shooting	26
• # 6 Dribbling, Crossing	27
• # 7 Passing	28
• # 8 Agility, Ball Control, Fun	29
• # 9 Circuit	30
• #10 Circuit with Passing and Control	31
PracticeBuilder Technical Skills	32
• # 1 3v2 with shot on goal	33
• # 2 2v2 give and go with shot on goal	34
• # 3 1v1, shot on goal	35
• # 4 Transition Play	36
• # 5 1v1	37
• # 6 4v4 Flank Attack	38
• # 7 4v4 in small area	39
• # 8 Two touch shooting	40
• # 9 1v2 Defending	41
• #10 Crossing and 2v1	42

## TABLE OF CONTENTS

PracticeBuilder Fitness Drills	43
• # 1 Pass and Sprint	44
• # 2 6v3	45
• # 3 Agility/Sprint	46
• # 4 Receive-Pass-Turn	47
• # 5 Reaction Sprint and 1v1	48
• # 6 3v1 with crossing	49
• # 7 Sprint and Score	50
• # 8 Dribble and Cross	51
• # 9 Sprint and 1v1	52
• #10 4v4 in penalty box with crossing	53
PracticeBuilder Tactical Drills	54
• # 1 3v3 with Target Player	55
• # 2 7v7 into four corners	56
• # 3 4+2 v 2+4	57
• # 4 6v4 Pressing and Counterattack	58
• # 5 Transition Play	59
• # 6 6v6 Flank Attack	60
• # 7 4v4+N Crossing	61
• # 8 Crossing	62
• # 9 4v3+GK	63
• #10 4v4 with 3 Groups	64
PracticeBuilder Scrimmages	65
• # 1 6v6 ½ Field	66
• # 2 Flank Attack	67
• # 3 1v1 Defending in 7v7	68
• # 4 7v7 with GK Transition Play	69
• # 5 Transition Play	70
• # 6 4v4 plus 3v2	71
• # 7 7v7 Flank Attack	72
• # 8 7v7 with Crossing	73
• # 9 8v8	74
• #10 5v4	75

## ACKNOWLEDGEMENTS

This book is dedicated to all coaches, players, parents and officials without whose passion for soccer the greatest game in the world could not exist.

We thank all the teams, players and coaches that have participated in developing the practice sessions and used them on the field them to make sure they work.

## Introduction

The idea for Print & Go practices and PracticeBuilder came from a recognition that something was missing for soccer coaches amongst all the training materials and resources available.

No doubt you have heard that a coach must have a practice plan when going to run a practice. If you are like most coaches, you probably have books and videos full of drills and practice ideas. If you are like most coaches, you also rush from work to the practice field desperately trying to write a practice plan in your head (hopefully not on paper while driving), organizing and visualizing drills and things to say. Maybe you even brought some books or photocopies of drills with you. Maybe you even roughed out a plan the night before on a piece of paper. No matter what, you either spent significant time researching and writing or significant time scrambling.

What about the next practice? What about a season plan? What about the team's needs and focus? Fitness training: yes or no? During practice or separate sessions? Scrimmages? Speed and mental training? Where are the drills for that? How about flexibility? Any difference between age groups?

To help you focus your time on deciding what is important for your team to work on we thought it would be a good idea to do the research and the writing for you. So we have developed a set of 10 complete practice sessions and a tool to develop hundreds of additional sessions. All you need to do is to decide on a focus for the season and a theme for each practice. The printed material is supplemented by pictures of stretches and moves and by the tips published on our website [www.soccerpracticebooks.com](http://www.soccerpracticebooks.com).

This is the second book in our series of Print & Go practice sessions and PracticeBuilder tools.

We recommend this set for competitive youth teams (travel teams, representative teams, regional teams, state/provincial teams, etc.), ages 13 and up, as well as for senior level amateur teams at all levels of competitiveness.

These practices and drills have been run with competitive 13 year old boys and 15 year old girls teams; and College teams.

We hope you will enjoy your season.

## Our Philosophy

Practices need to be fun for players and coaches. Drills must be interesting and vary across skills, tactics, strategies, mental and physical fitness and team building.

Players need to be busy with a ball at all times to maximize the number of touches they get with the ball.

Practices must flow and time must not be wasted by the coach setting up or thinking about drills.

Practices and drills must have a purpose.

We suggest you schedule 2 hours for the practice and ask your players to be ready to warm up at the scheduled time. A break is suggested after the fitness drill. Any delay in starting will cut into the all important and popular scrimmage time.

We suggest that each practice starts with a brief meeting between coaches and players in which the theme of the practice is communicated to the players.

Then start with a warm up. You will notice that our warm-ups already incorporate the theme of the practice, lots of ball work, fitness and thinking exercises in a purely soccer way. No repetitive running, not many exercises without a ball and if so, then they are fun and challenging.

We have cushioned the fitness section between technical and tactical drills. The reason is that we want players to be properly warmed up for skill work, but then challenge their stamina and mind by requiring technical skills after fitness work.

End with a scrimmage and feel free to adapt them or change them to suit your team's needs.

After the practice, have a quick meeting again for going over the practice briefly, invite comments from the players, congratulate them on their effort and improvement and make any announcements regarding upcoming events.

During the drills, be patient. Observe and intervene only when needed. Keep your comments positive, to the point and brief. Speak loudly and clearly. It is better to demonstrate a drill or a concept than to give a speech. Never yell at a player or use derogatory language.

## Print & Go Practices – Usage Recommendations

We have developed a matrix for the 10 sessions showing the focus of the practice and of each of the drills in the practice. Please study the matrix to become familiar with the content of each session and drill.

On the matrix page is a box suggesting various ways to sequence these sessions. Chose the emphasis for your next 10 practices (which could be a season or pre-season) and study the sequence suggested. Of course, you are free to develop your own sequence. Refer to the individual practice sheets or the individual PracticeBuilder drill sheets for a better understanding. Write comments on the drill sheets.

We suggest you visualize the drills to make sure you understand how they will flow. If necessary, set them up in your living room and walk through them.

Keep a clean copy of the book at home and put the pages you take to the practice with you in clear plastic sheet protectors to protect them from water or other disturbances (you know what can happen to papers).

## PracticeBuilder – Usage Recommendations

The PracticeBuilder was designed for two purposes.

Firstly, to have a “bigger picture” of the exercises to work from and to allow you to make notes of what or whom you want to observe before you start the drill and notes of what you learnt from the drill. The pages fit nicely on a clipboard.

Secondly, we wanted to make it easy for you to create your own practices by simply pulling a number of drills and arranging them in a sequence that meets your needs.

We recommend that you stick with our general practice philosophy and at a minimum suggest you start with a warm-up and end with a scrimmage. In between, you can design whichever way. If your team needs 4 fitness sessions and no technical/tactical work- go for it. You want to work three shooting related sessions- they are ready to go.

## Feedback

We always look for ways to improve. So any suggestions are welcome. Please E-mail them to [coach@soccerpracticebooks.com](mailto:coach@soccerpracticebooks.com).

Practice #	Practice Focus	Warm-Up Focus	Technical Drill	Fitness Focus	Tactical Drill	Scrimmage Focus
1	Fast Break Attack	Passing Headers	3v2 with shot on goal pass and sprint	6v3 in penalty area regular+2 small goals	3v3 with target player	6+GK v 6 half field regular goal+2wide goals
2	Flank Attack Scoring	Dribbling 1v1	2v2 give and go with shot on goal	6v3 in penalty area regular+2 small goals	7v7 into 4 corners	cross dribble and cross
3	Defending	Dribbling Agility	1v1 with shot on goal	Agility Sprint	zone defending 4+2 v 2+4	7v7+GK setting up 1v1 on goal
4	Passing Anticipation Transition	Anticipation Passing	Transition Play 4v4 on 2 goals	Receive-Pass-Turn	6v4 Pressing Counterattack	7v7 with GK Transition Play
5	Scoring Transition	Dribbling Shooting	2v2 with GK plays as 2x 1v1	Reaction sprint and 1v1	3 v 3 penetration passing and shooting	6v6 +GK play in one half and score in other half
6	Flank attack Ball Control	Dribble Crossing	4v4 + 4 neutrals with GK on 2 goals ank attack	3v1 with crossing	6v6 + GK ank attack	4v4 + 2x 3v2 with GK Full size goals
7	Scoring Goals Flank attack	Passing	4v4 with GK score on either goal in small area	Sprint and score kick, head	4v4 with N crossing 2 teams on large goal in penalty area	7v7 full dd score on either goal after cross
8	Crossing Balls Scoring	Agility Ball Control Fun	Two touch Shooting	Dribble and cross sprint back	Crossing from spot and after pass. with/without challenge	7v7 +GK with crossing
9	Defending	Circuit Dribble, pass, shoot	1v2 defending	Sprint and 1v1	4v3 +GK 1 large, 2 small goals	8 v 8 defend small goals
10	Scoring Goals Flank attack #2	Circuit Passing & Control	Crossing and 2v1	4v4 in penalty box with crosses	4v4 with GK 3 groups	5 v 4+GK

## Practice sequence Suggestions

Coaching Emphasis	Practice Sequence
Pre-Season	3-4-2-5-1-8-7-9-6-10
Season Build	9-3-1-8-4-2-6-7-10-5
Scoring	5-7-8-10-6-2-1-3-9-4
Defending	9-3-2-10-1-4-6-7-5-8
Mid field	1-4-10-2-5-6-9-3-7-8
Fitness Build	4-5-9-10-3-2-1-7-8-6

# Youth Competitive Senior Amateur

 Print & Go

## Practices



# Youth Competitive/Senior Amateur # 1

**Practice Focus: Fast break attack #1** □□

□□□

**Time: 2 hrs**

## Warm-Up: Passing, Headers 1v.1 (30 min.)

1. Set up 10-15 (2m wide) goals. In partners, freely move around passing the ball through all goals.
2. Runner's stretch (hold 20 sec. each side, 3 reps/side)
3. Groups of three players form triangles 5m apart. Player 1 throws to P2, who heads ball to P3. P3 to P1, etc.
4. Quad stretch (hold 20 sec. each side, 3 reps/side)
5. 4 pairs play 1v1 in a 25m x 25m grid with 2 full size goals and goalkeeper.
  - 2 neutral players in the grid can be used by any pair.
  - a shot on goal must follow a give and go with one of the neutrals.
6. Hamstring stretch (hold 20 sec. each side, 3 reps/side)
7. Same set-up as #5. 4 players on diagonally opposite sides of goal.
  - first pair plays 1v1 on opposing goal. X's start with ball.
  - after first round, o's start with ball.
8. Heel stretch (hold 20 sec. each side, 3 reps/side)

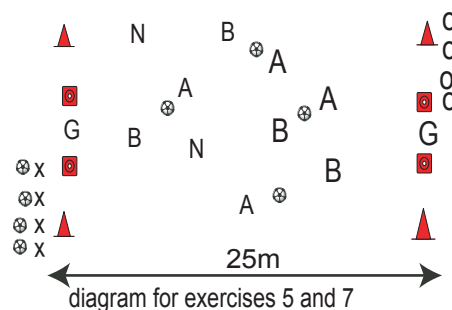

## Technical Skill: 3 v 2 with shot on goal (20 min.)

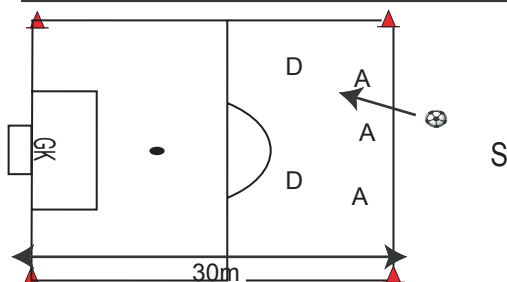

Server plays ball to one of the attackers outside the penalty area. Attackers play 3 v 2 and try to combine to shoot on goal. If defenders win ball, they must play it back to server who restarts play.

You can set this up in two groups or extend size of groups to keep all players occupied. Or, if space is limited, have a second group work on skills and rotate the groups.

Play each game for 5 minutes.

## Fitness Focus: Pass and Sprint (15 min)

x's pass ball between each other until one of them passes it forward. That is command for o's to sprint to ball and play 1 v 1 on goal.

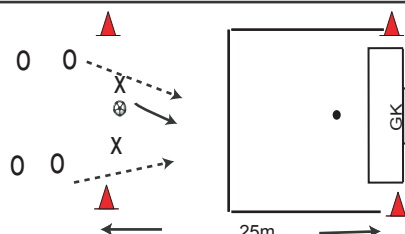

## Tactical Focus: 3 v 3 with target player (20 min)

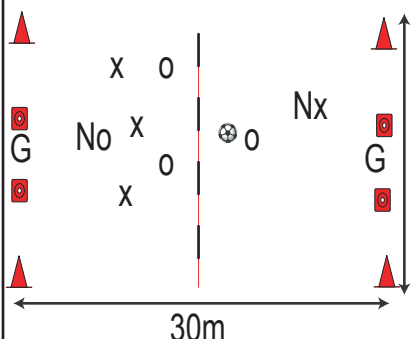

30 x 40 m grid  
3 x's vs 3 o's  
each team has a neutral, Nx and No who stay in other half  
One pt for goal, 2 pts after give/go w. Neutral

## Scrimmage focus: 6 v. 6 - 1/2 field (30 min)

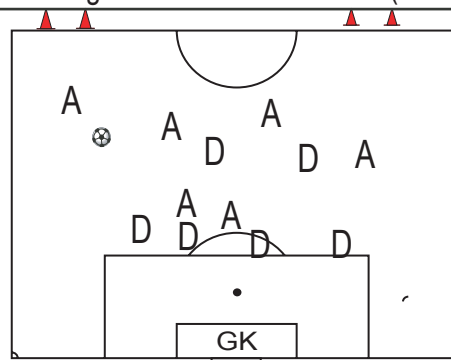

attackers play on goal.  
defenders counter through small goals  
players play regular positions  
10 min. games

Players should be busy at all times. If drills keep players inactive, break team into smaller groups and run parallel drills.



# Youth Competitive/Senior Amateur # 2

**Practice Focus: Flank attack, scoring** □□□

□□□

**Time: 2 hrs**

## Warm-Up: Dribbling, 1v.1 (30 min.)

1. Set up 10-15 (2m wide) goals. Each player dribbles through each goal, accelerating out of goal and changing direction.
2. Runner's stretch (hold 20 sec. each side, 3 reps/side)
3. X ⊕ ▲ ▲ dribble through cones making the figure 8 
4. Quad stretch (hold 20 sec. each side, 3 reps/side)
5. AvB in a 15m x 15m grid with 4 small goals. 2 other pairs wait outside grid, i.e. 3 pairs/grid.  
A defends adjacent goals G1 and B defends goals G2.  
Play for 60 seconds and rotate pairs into grid. Each pair plays twice.  
Hamstring stretch (hold 20 sec. each side, 3 reps/side) while waiting
6. Same set-up as #5. 2 pairs in grid now playing 1 v.1 independent of each other.  
After 60 sec., rotate one pair with the third pair waiting. 3 games.
7. Heel stretch (hold 20 sec. each side, 3 reps/side) while waiting.

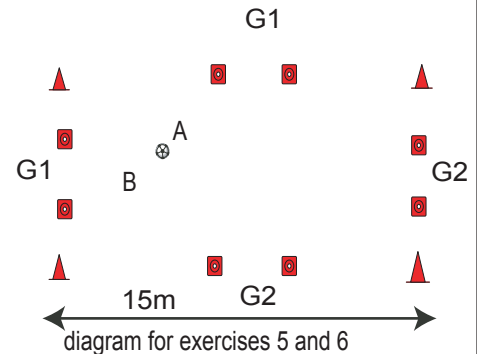

## Technical Skill: 2 v 2 give and go with shot on goal (20 min.)

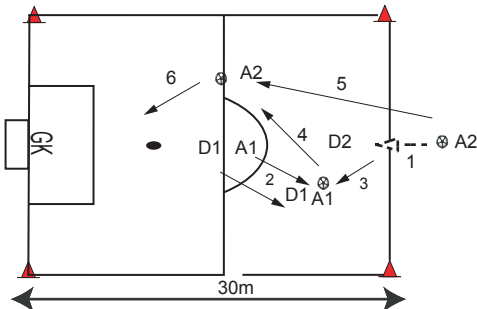

1. A2 dribbles towards D2 who comes towards A2
  2. A1 makes a diagonal run behind D2. D1 follows A1.
  3. A2 passes to A1.
  4. A1 rotates quickly and one touch passes diagonal towards sideline into
  5. A2 run which is around D2 to the outside
  6. A2 should now be clear on net.
- This drill will require patience by the coach and players because of the difficulty of the precision required in timing runs and passes. Keep trying - when it works in games it is powerful.

## Fitness Focus: 6 v. 3 (15 min)

- 6 x's play two touch and attack large goal.  
3 o's defend large goal and try to score into small goals.
- Play 3 games of 3 minutes each rotating everyone through defense
- Set up two games if team has enough players.

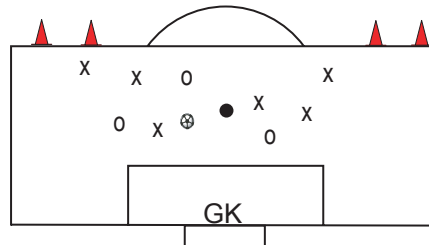

## Tactical Focus: 7 v 7 into four corners (25min)

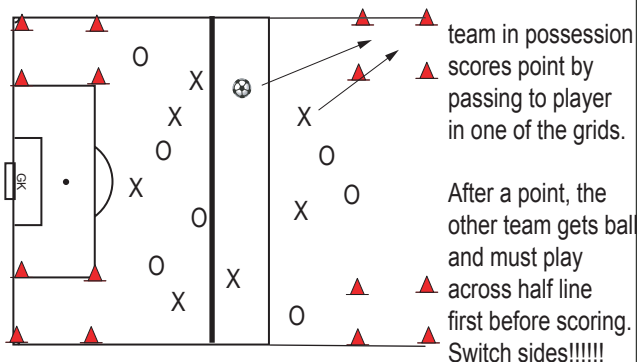

## Scrimmage focus: Flank Attack (30min)

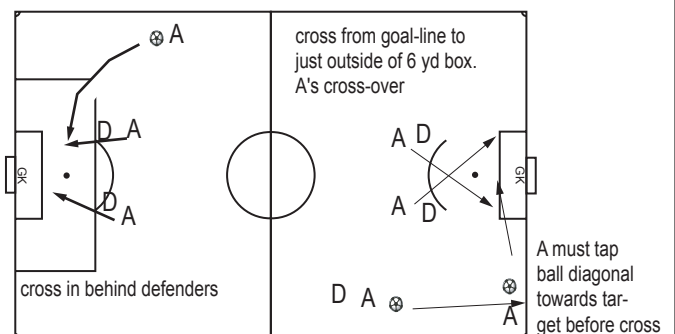

Players should be busy at all times. If drills keep players inactive, break team into smaller groups and run parallel drills.



# Youth Competitive/Senior Amateur # 3

Practice Focus: Defending □□□ □ □□□

Time: 2 hrs

## Warm-Up: Dribbling, agility (30 min.)

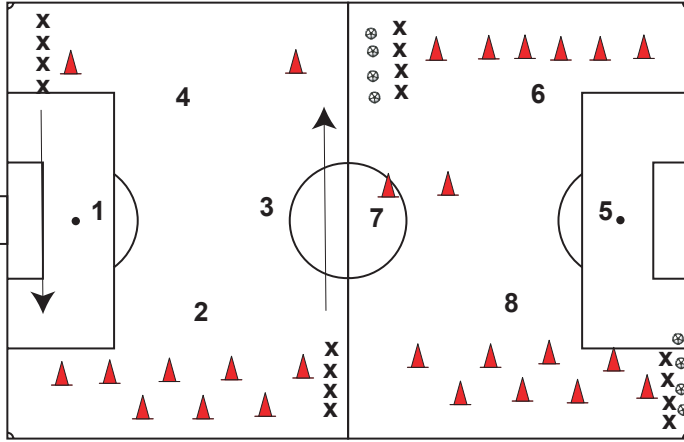

Split team into four groups and position at stations 1,3,5,7. Have each group go through circuit in their half once, then stretch (runners). Switch groups to other half of field and do a circuit, stretch (quads). Have groups do circuit in same half in reverse direction and stretch (hamstring). Switch groups back to their original half of field and do circuit in opposite direction of their first circuit, heel stretch. The following are the warm-up exercises at each station:

1. easy jog
  2. sideway run, cone to cone.
  3. jog with three complete turns, switching direction of turn.
  4. jog with header jumps every 5 m.
  5. dribble ball.
  6. dribble through cones.
  7. pass to yourself through cones, receive ball while it is still moving.
  8. dribble zig zag keeping the ball inside the cones.
- Vary distances between cones to suit skill of your team.

## Technical Skill: 1 v 1 shot on goal (20 min.)

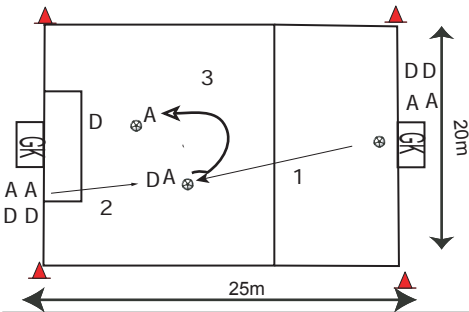

Split team into two groups if possible and set up drill as shown.

1. GK rolls/throws ball to Attacker at opposite goal.
2. Attacker sprints to ball followed by defender.
3. Attacker tries to set up first touch away from defender allowing him/her to turn and play 1v1 against defender.

After attempt at net or stop-play by coach, the play now starts from other end.

Let defender be passive if attackers have no success initially.

## Fitness Focus: agility/sprint (15 min)

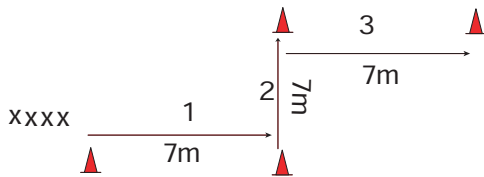

Split team into groups of 3-5 players and set up an exercise area for each group.

1. Two leg (up) hop.
2. Sidestep shuttle run.
3. Explosive forward sprint.

## Tactical Focus: 4+2 v. 2+4 (25min)

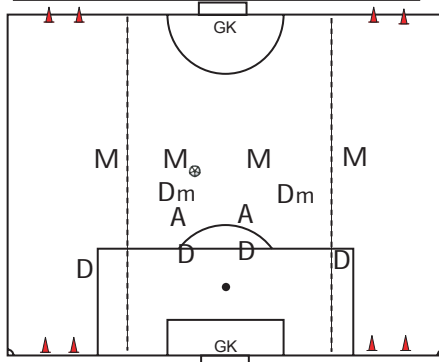

4 midfielders (M) and 2 attackers (A) play v. 4 defenders (D) and 2 defending midf.(Dm)

Field is divided into 3 zones. Goals scored into regular goals = 1pt

Goals scored into wide goals while a defender is trapped in far zone = 2pts.

## Scrimmage focus: 1 v 1 defending in 7 v 7 (30min)

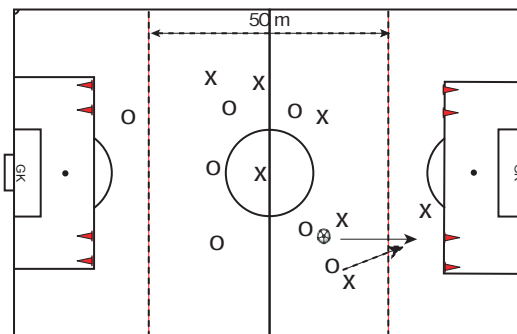

6 v 6 play in 50 m zone. Purpose is to pass deep to player into endzone defended by one defender. Play is 1 v 1 in endzone on 2 small goals. After goal is scored or defender wins ball, defender plays it out into 50m zone to his/her team.

Players should be busy at all times. If drills keep players inactive, break team into smaller groups and run parallel drills.



# Youth Competitive/Senior Amateur # 4

Practice Focus: passing, anticipation, transition □ □ □□

Time: 2 hrs

## Warm-Up: anticipation, passing (30min)

1. groups of 5-7 players in a 20m x 20m grid. Players pass to each other and follow their pass. Players must call to receive the ball.
2. Runner's stretch (3x30 sec, each leg).
3. Same groups of players, players numbered starting with #1. Players must pass to each other in numerical sequence.
4. Hamstring stretch (3x30 sec each).
5. give and go in a 15m x 15m grid

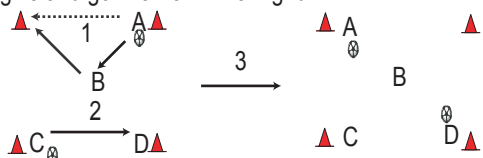

1. A plays give and go with B to open cone.
  2. C passes ball to D.
  3. This is how the situation looks after first two passes.
- Now D plays give and go with B and A passes to C.  
Play continues and must be fluid. Players rotate through middle after 3 minutes.

6. Quad stretch (3x30 sec each).
7. In pairs, players pass one touch to each other (give and go) across field and back.
8. Heel stretch.

For details on stretches, please visit [www.soccerpracticebooks.com](http://www.soccerpracticebooks.com)

## Technical Skill: Transition Play (25 min.)

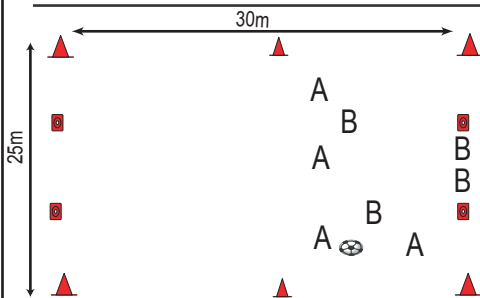

- 4 v. 4 on two full size goals.
- two defenders (B) must be on goal line before other players (B) can tackle attackers (A).
  - after change of possession to defending team (B) or goal, A's must get two players on goal line before other two can tackle the other team (B's).
  - meanwhile, attacking team must have all 4 players in other half before they can score.
- This drill requires a lot of positive communication, who's on goal line, when, etc.

## Fitness Focus: receive-pass-turn (10 min)

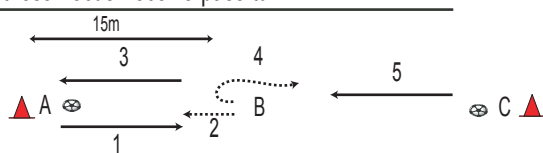

1. A passes to B who
2. attacks ball and
3. one-touch passes it back to A and
4. immediately turns and sprints towards ball
5. passed by C.

Repeat for 3 minutes and rotate through middle position.

## Tactical Focus: 6 v. 4 pressing and counterattack (25min)

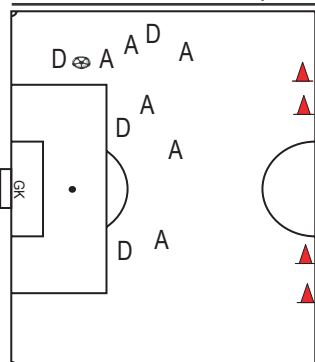

1. Defenders D win ball and try to counterattack on 2 small goals at half.
2. Closest attacker A challenges D with ball and second attacker covers right behind in support.
3. Other attackers close in on ball while taking away passes to other defenders.

## Scrimmage focus: 7 v. 7 with GK transition play (30min)

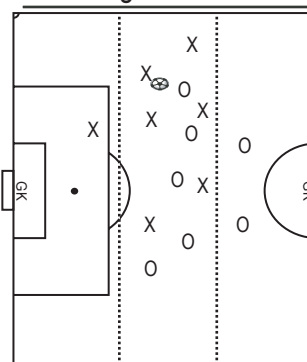

1. divide half field into 3 equal zones.
2. team in possession must have all players at least in middle zone before they can score. (On diagram shown, last X in own third must move up).
3. In own defending zone, players have to play two-touch until ball is out of defensive zone. free play in middle and attacking zone.

Players should be busy at all times. If drills keep players inactive, break team into smaller groups and run parallel drills.





# Youth Competitive/Senior Amateur # 6

Practice Focus: **Ball Control, Flank Attack** □ □ □ □ □ □ □ □

Time: **2 hrs**

## Warm-Up: Dribble, Crossing (30min)

1. Dribble ball with outside of foot. Stop with ball of foot. Take away at right angle with outside of same foot. Keep repeating, alternating feet.
2. Runner's stretch.
3. Dribble and execute scissors move at highest pace to maintain sharp change of direction. If necessary, dribble towards cones and make move.
4. Quad stretch.
5. Groups of three pass the ball to each other down one side of the field. One of the three calls for a final pass to the corner, while the other two make a run to the near and far posts. Player in the corner crosses ball in and players at posts try to score, headers preferred. Group of three now goes across and starts down other side of field. All groups shown should be moving at the same time.
6. Hamstring stretch.
7. Half the players have a ball and are spread out inside penalty area. Players without ball sprint to any player with ball and call for the ball. Ball is thrown to their foot or head and played back with one touch. Players alternate positions every 30 seconds.
8. Heel stretch.

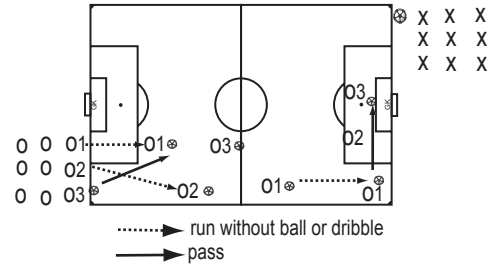

## Technical Skill: 4v4 flank attack (30 min)

4v4 with 4 neutral players on sidelines.  
 Team in possession can use neutral players.  
 Quick passes into corners for crosses and finishing.

Rotate teams every 3 minutes.  
 If there are extra players, make four teams, set up two fields and play without neutrals.

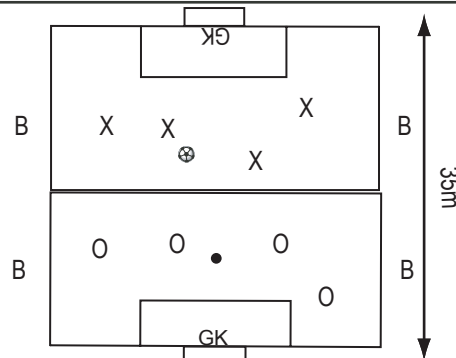

## Fitness Focus: 3v1 with crossing (15min)

3 groups play 3v1 inside 10mx10m grid

Groups 1 and 2 alternate sending a player to the corner with a pass. Player crosses to group 4 who plays 3v1 on goal.  
 Rotate groups every 3 min.

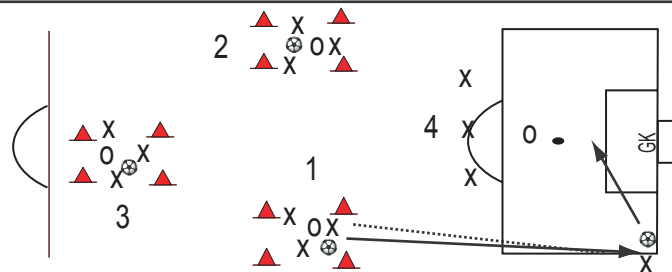

## Tactical Focus: 6v6 flank attack (20 min)

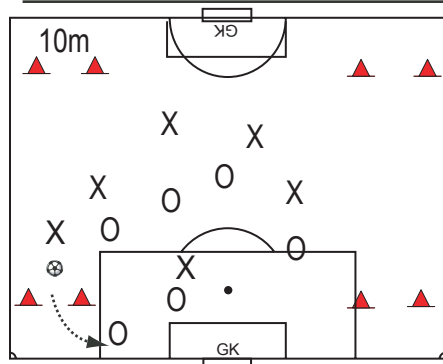

Teams must pass or dribble through cones before they can cross on goal

Substitute extra players as you go

## Scrimmage focus: 4v4 & 3v2 (25 min)

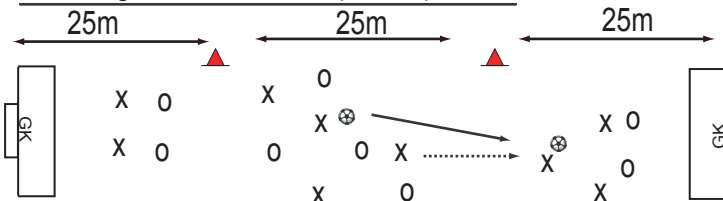

Full width of field is divided into 3x25m long sections.

4v4 in middle section: team in possession tries to send a player into one end section for a 3v2 on goal. Restart in middle

Players should be busy at all times. If drills keep players inactive, break team into smaller groups and run parallel drills.



# Youth Competitive/Senior Amateur # 7

Practice Focus: Scoring Goals, Flank Attack □□ □ □□□

Time: 2 hrs

## Warm-Up: Passing (25 min)

1. In pairs, players pass back and forth across the field using two touches on the ball.
2. Runner's stretch.
3. In pairs, players face each other 2m apart. They one-touch pass the ball to each other while increasing the distance between them to 25m. They then decrease the distance while passing back to 2m.
4. Quad stretch.
5. In pairs, facing each other, one-touch pass the ball to each other while shuttling (side stepping) to the half and back.
6. Hamstring stretch.
7. In pairs, one touch pass the ball to each other while moving around half the field twice.
8. Heel stretch.

Note: While these passing drills seem simple, they increase in difficulty if the coach demands 100% accuracy and proper weight and insists on number of touches specified.

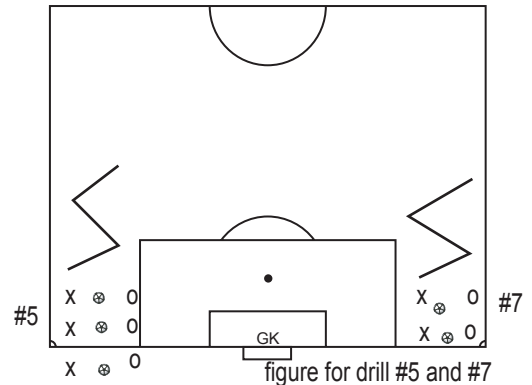

## Technical Skill: 4 v4 in small area (35 min)

Play 4v4 on full size goals with GK in area twice the size of the penalty area.

X's can score in either goal, but must cross centerline first after scoring a goal or losing possession. After crossing centerline, they can attack either goal again.

6X5 minute games, switching roles of X's and O's  
Play on two fields if you have enough players.

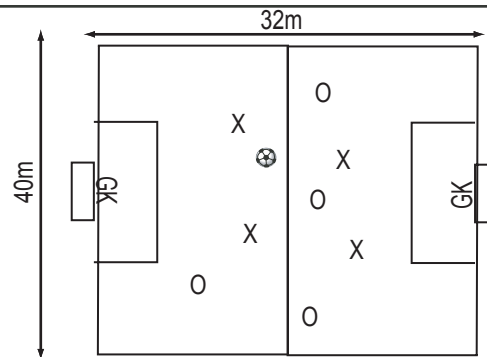

## Fitness Focus: sprint and score (15 min)

1. Server (S) rolls or throws ball parallel to 5m line.
2. X and O, starting at the top of the penalty area, sprint to ball and try to score. X tries to get to ball on the near side and if X misses, O tries to convert from the far side.
3. Players try to score alternating, based on coach's instruction and throw :  
a. run and kick, b. run and slide into ball, c. diving header, d. run and head.

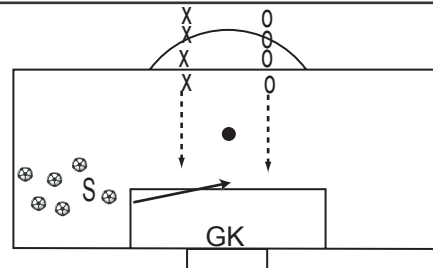

## Tactical Focus: 4v4+N crossing (20 min)

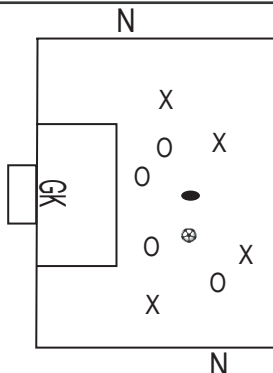

X v O play on one goal inside penalty area.

Team in possession must play to either neutral player who must cross the ball.

Goal can only be scored from a cross by the team that played to N.

If defending team wins ball, they play to N so they can score.

Set up 2 fields or rotate teams of 4.  
3 minute games, change N's

## Scrimmage focus: 7v7 Flank attack (25 min)

X v O, full field.

Both teams can score on either goal after playing to a teammate in one of the corner squares.

In square, player can not be challenged.

Teams must play across center-field before they can score again.

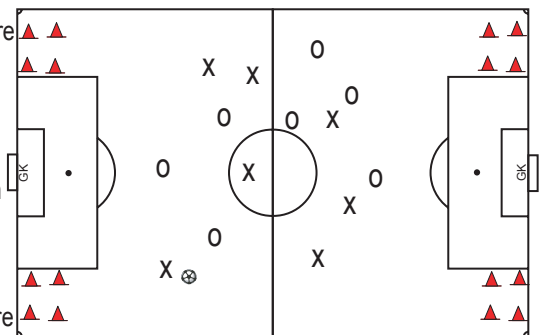

Players should be busy at all times. If drills keep players inactive, break team into smaller groups and run parallel drills.



# Youth Competitive/Senior Amateur # 8

**Practice Focus: Crossing Balls, Scoring** □ □ □ □ □ □ □ □

**Time: 2 hrs**

## Warm-Up: Agility, Ball Control, Fun (30 min)

All drills are in the penalty area.

1. Half of the players have a ball, the other half is spread out in the area, standing with legs apart. Players with ball dribble and pass ball to themselves through the legs of each of the other players. After each player has completed the round, switch roles.
2. Runner's stretch.
3. Same as (1), except players without ball lie on their backs, spread out in the area. Players with ball dribble and chip ball over players lying down. Switch after each player has completed round.
4. Hamstring stretch.
5. Same as (1), except players without ball make an arch with hands extended on ground in front of the body. Players with ball dribble and pass it to themselves through the arch. Switch roles.
6. Quad stretch.
7. Same as (1), except players without ball kneel on hands and knees with head tucked in, to make a very compact "box". Players with ball chip ball over "box". Switch roles.
8. Heel stretch.

## Technical Skill: Two touch shooting (15 min)

1. Players on goal line play a firm pass out to players waiting at top of penalty area.
2. Players receive ball and set up shot with their first touch, which should be diagonally ahead.
3. On second touch, players take a shot aiming for the far post.

Players passing run to the end of line at top of box.  
Shooters run to end of passing line. Switch sides after each round.

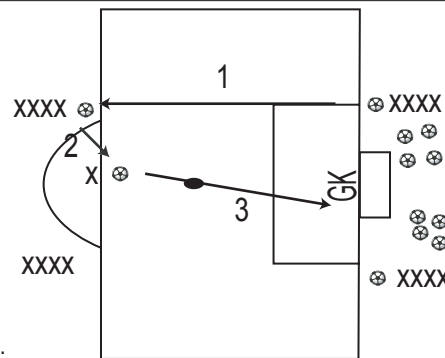

Tips for shooting:

1. Look at target before receiving ball.
2. Keep eye on ball
3. Laces down and ankle locked for shot.

## Fitness Focus: Dribble and cross (15 min)

1. X with ball dribbles past cone and
  2. Crosses ball outside of 5m line.
  3. Players at top of area delay run and once they judge the flight of the ball, sprint in for shot/header.
- Players sprint back to their starting position. Alternate sides.

Set up at other goal if number of players is too large to keep drill fast

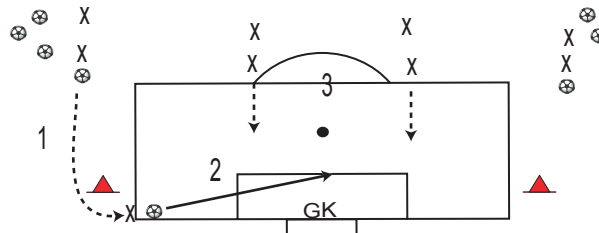

## Tactical Focus: Crossing (30 min)

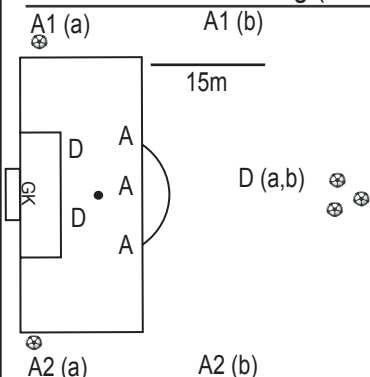

Drill (a):  
A1 /A2 (a) alternate crosses into box for 3 A's to score v. 2 D's. If D's win ball, they play it out to D (a,b).  
Drill (b):  
D (a,b) passes ball into run of A1 (b) or A2 (b). One of the defenders (D) comes out to challenge A1/2 who must get a cross in.

## Scrimmage focus: 7v7 with crossing (30 min.)

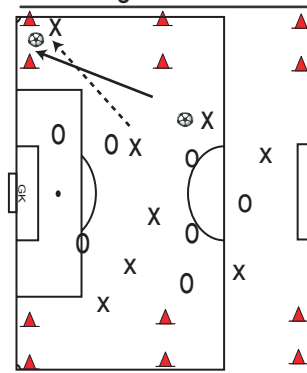

7 v 7 play 3 touch max. per player in the marked field.  
The cones on either side mark a "free crossing" lane.  
A player receiving a ball in free lane cannot be challenged and gets a free cross on goal.  
Goals scored from crosses count as 2 points. Regular goal counts as 1 pt.  
Make sure teams mix up playing for crosses and through middle.

Players should be busy at all times. If drills keep players inactive, break team into smaller groups and run parallel drills.



# Youth Competitive/Senior Amateur # 9

Practice Focus: Defending □□ □ □□□

Time: 2 hrs

## Warm-Up: Circuit (30 min)

1. players dribble ball in square and one at a time leave.
2. dribble through cones
3. lines are hurdles (could be equipment bags, cones) player passes to coach (C) and sprints over hurdles to receive return pass from coach
4. Player passes through small goal and sprints around outside of cone to receive his pass (moving ball)
5. Speed dribble to half way line
6. Dribble around cone to set up shot on goal.

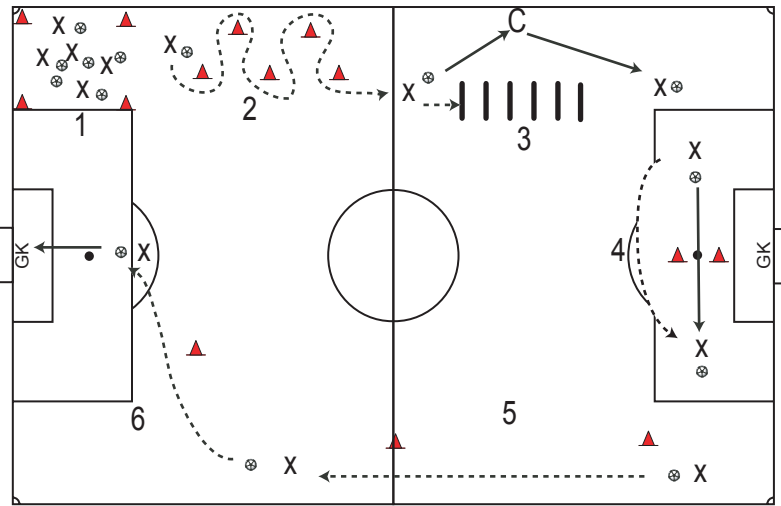

After one circuit, players do runner's stretch, repeat circuit-hamstring stretch, repeat circuit-quad stretch, repeat circuit-heel stretch.

Be sure that players don't leave station 1 too early to avoid jam up in station 2.

## Technical Skill: 1v2 Defending (20 min)

- A1 plays 1v2 against D on small goal.
- A2 waits next to goal players A are defending.
- A1 can pass to A2 who now plays 1v2, while A1 drops back to goal.

If a D wins ball, D now plays 1v2 against A1/A2 while second D drops back to his goal.

Play 5 x 3 minutes with 1 minute rest between games.  
Set up as many playing areas as needed to keep everyone playing

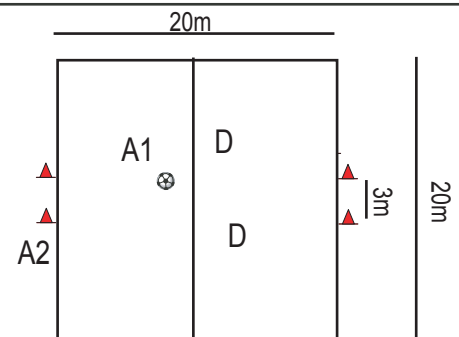

## Fitness Focus: Sprint and 1v1 (20 min)

- A sprints to ball which is signal for D to sprint to the same ball.
- First player to touch ball is attacker and plays 1v1 against other player on goal.
- Set up enough goals to keep players moving.

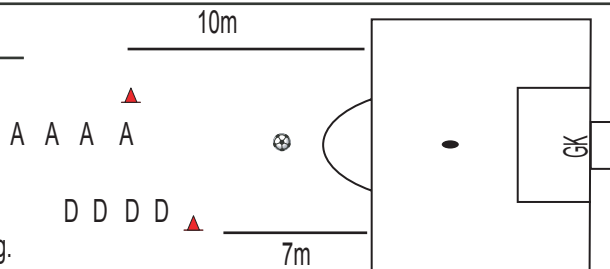

## Tactical Focus: 4 v 3+GK (20 min)

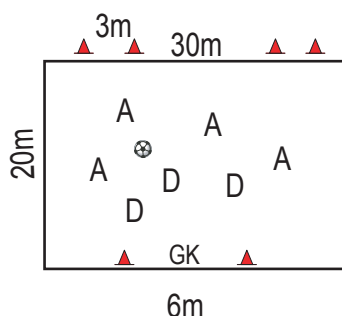

- A attack large goal
- D attack two small goals
- 5 X 3 min. games with 1min rests in between.
- set up 2 fields

## Scrimmage focus: 8v8 (30 min.)

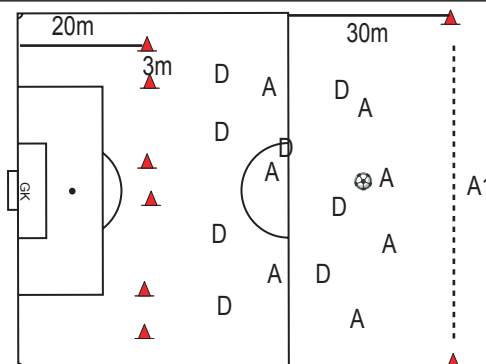

Attackers (A) must dribble through small goal to score. They can not be challenged after they pass through small goal. If defenders (D) win ball, they play it to A1 who waits in neutral zone and restarts attack.

Players should be busy at all times. If drills keep players inactive, break team into smaller groups and run parallel drills.



# Youth Competitive/Senior Amateur # 10

**Practice Focus: Scoring, Flank Attack #2** □ □ □ □

**Time: 2 hrs**

## Warm-Up: Circuit with Passing&Control (30 min)

Work in pairs:

1. one touch passing down sideline
2. one touch passing across field, one player running forward, other runs backwards.
3. two touch passing down sideline
4. X running forward throwing ball to player running backwards who heads it back.

circuit-runner's stretch-circuit-hamstring stretch-circuit-quad stretch-circuit-heel stretch.

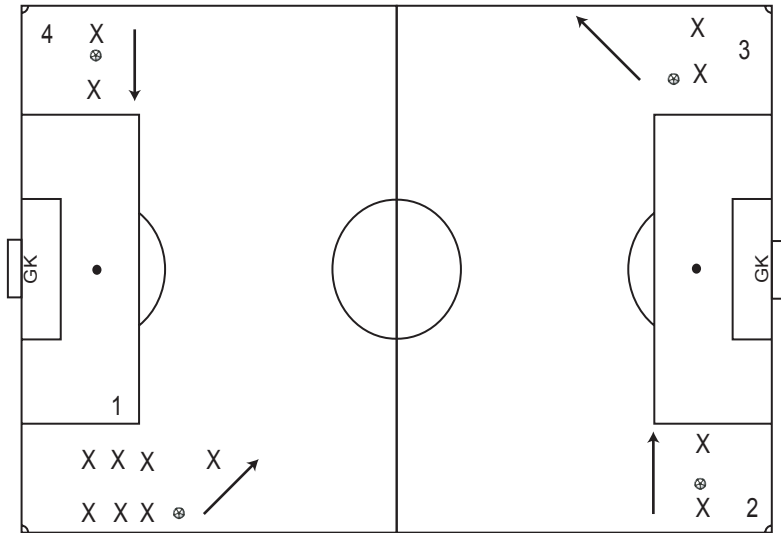

## Technical Skill: Crossing and 2v1 (15 min)

x dribbles outside penalty area and crosses ball in

A play 2v1 v. D on goal. If D touches ball, restart.

Alternate D's.

Set up as many areas and goals as necessary to keep everyone moving.

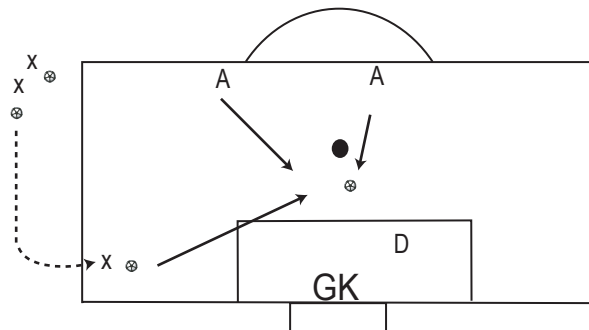

## Fitness Focus: 4v4 in penalty box with crosses (20 min)

4 v 4 in penalty area, each team attacks opposite goal.

Teams can use players on sideline for crosses.

Players on sideline cannot be challenged once they have ball.

3 minute games. Extra players jog around field and get rotated in every three minutes.

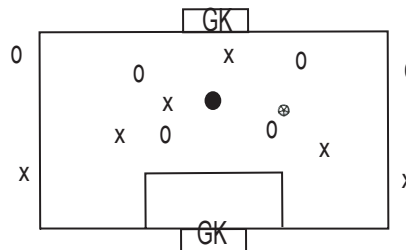

## Tactical Focus: 4v4 with 3 groups (25 min)

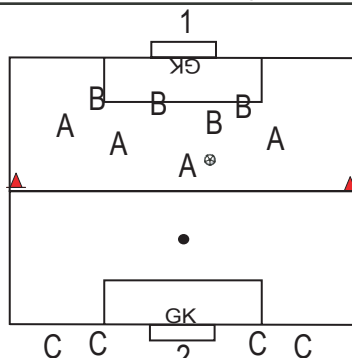

A attacks goal 1 which B defends.  
If A scores, game starts again.  
If B wins ball, they must cross half-line.  
Once B crosses over, C comes out to defend goal 2 which B attacks.  
A drops to goal line 1 and waits for C to come across and attack

## Scrimmage focus: 5v4 (30 min)

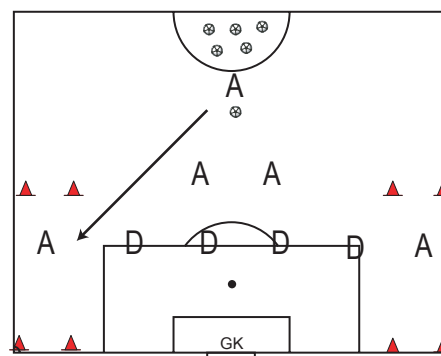

A passes ball to one of A's in a side-zone.  
Once A receives ball, D's can challenge.  
A's now play 5v4 on goal.

If Ds win ball they clear it out and A restarts.  
After goal, A restarts.  
Set up two fields or substitute players in.

Players should be busy at all times. If drills keep players inactive, break team into smaller groups and run parallel drills.

# Youth Competitive Senior Amateur



Practice  
Builder

Warm-Ups



# Practice Builder



Team: \_\_\_\_\_

Date: \_\_\_\_\_

## Warm-Up

Things to observe: \_\_\_\_\_

\_\_\_\_\_

\_\_\_\_\_

\_\_\_\_\_

Notes: \_\_\_\_\_

\_\_\_\_\_

\_\_\_\_\_

### Warm-Up #1: Passing, Headers 1v.1 (30 min.)

1. Set up 10-15 (2m wide) goals. In partners, freely move around passing the ball through all goals.
2. Runner's stretch (hold 20 sec. each side, 3 reps/side)
3. Groups of three players form triangles 5m apart. Player 1 throws to P2, who heads ball to P3. P3 to P1, etc.
4. Quad stretch (hold 20 sec. each side, 3 reps/side)
5. 4 pairs play 1v1 in a 25m x 25m grid with 2 full size goals and goalkeeper.  
2 neutral players in the grid can be used by any pair.  
a shot on goal must follow a give and go with one of the neutrals.
6. Hamstring stretch (hold 20 sec. each side, 3 reps/side)
7. Same set-up as #5. 4 players on diagonally opposite sides of goal.  
first pair plays 1v1 on opposing goal. X's start with ball.  
after first round, o's start with ball.
8. Heel stretch (hold 20 sec. each side, 3 reps/side)

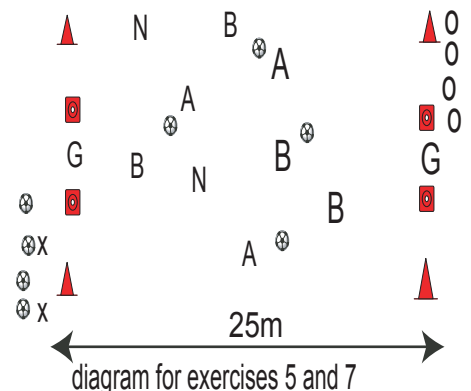



# Practice Builder



Team: \_\_\_\_\_

Date: \_\_\_\_\_

## Warm-Up

Things to observe: \_\_\_\_\_

\_\_\_\_\_

\_\_\_\_\_

\_\_\_\_\_

Notes: \_\_\_\_\_

\_\_\_\_\_

\_\_\_\_\_

### Warm-Up #2: Dribbling, 1v.1 (30 min.)

1. Set up 10-15 (2m wide) goals. Each player dribbles through each goal, accelerating out of goal and changing direction.
2. Runner's stretch (hold 20 sec. each side, 3 reps/side)
3. X ⊕ ▲ ▲ dribble through cones making the figure 8 
4. Quad stretch (hold 20 sec. each side, 3 reps/side)
5. AvB in a 15m x 15m grid with 4 small goals. 2 other pairs wait outside grid, i.e. 3 pairs/grid.  
A defends adjacent goals G1 and B defends goals G2.  
Play for 60 seconds and rotate pairs into grid. Each pair plays twice.  
Hamstring stretch (hold 20 sec. each side, 3 reps/side) while waiting
6. Same set-up as #5. 2 pairs in grid now playing 1 v.1 independent of each other.  
After 60 sec., rotate one pair with the third pair waiting. 3 games.
7. Heel stretch (hold 20 sec. each side, 3 reps/side) while waiting.

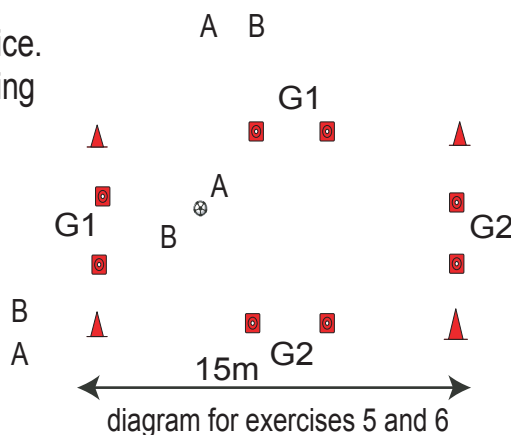



# Practice Builder



Team: \_\_\_\_\_

Date: \_\_\_\_\_

## Warm-Up

Things to observe: \_\_\_\_\_

\_\_\_\_\_

\_\_\_\_\_

\_\_\_\_\_

Notes: \_\_\_\_\_

\_\_\_\_\_

\_\_\_\_\_

### Warm-Up #3: Dribbling, agility (30 min.)

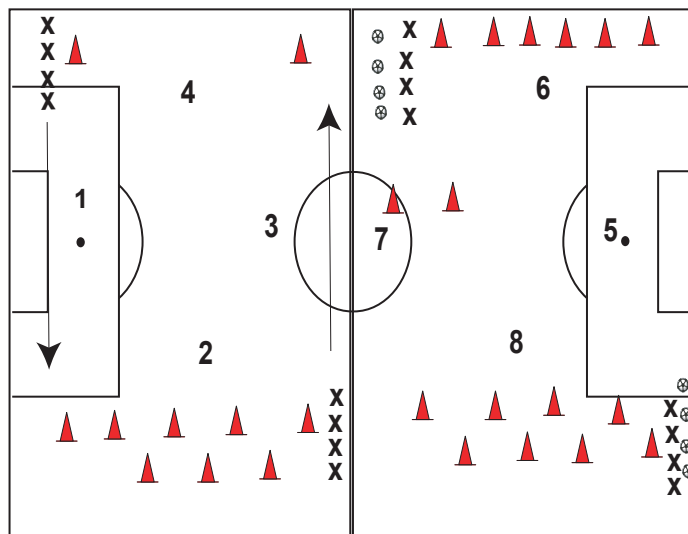

Split team into four groups and position at stations 1,3,5,7. Have each group go through circuit in their half once, then stretch (runners). Switch groups to other half of field and do a circuit, stretch (quads). Have groups do circuit in same half in reverse direction and stretch (hamstring). Switch groups back to their original half of field and do circuit in opposite direction of their first circuit, heel stretch.

The following are the warm-up exercises at each station:

1. easy jog
2. sideway run, cone to cone.
3. jog with three complete turns, switching direction of turn.
4. jog with header jumps every 5 m.
5. dribble ball.
6. dribble through cones.
7. pass to yourself through cones, receive ball while it is still moving.
8. dribble zig zag keeping the ball inside the cones.

Vary distances between cones to suit skill of your team.



# Practice Builder



Team: \_\_\_\_\_

Date: \_\_\_\_\_

## Warm-Up

Things to observe: \_\_\_\_\_

\_\_\_\_\_

\_\_\_\_\_

\_\_\_\_\_

Notes: \_\_\_\_\_

\_\_\_\_\_

\_\_\_\_\_

### Warm-Up #4: anticipation, passing (30min)

1. groups of 5-7 players in a 20m x 20m grid. Players pass to each other and follow their pass. Players must call to receive the ball.
2. Runner's stretch (3x30 sec, each leg).
3. Same groups of players, players numbered starting with #1. Players must pass to each other in numerical sequence.
4. Hamstring stretch (3x30 sec each).
5. give and go in a 15m x 15m grid

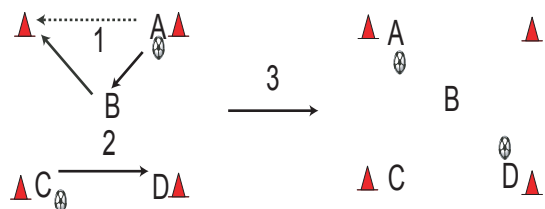

1. A plays give and go with B to open cone.
2. C passes ball to D.
3. This is how the situation looks after first two passes. Now D plays give and go with B and A passes to C. Play continues and must be fluid. Players rotate through middle after 3 minutes.

6. Quad stretch (3x30 sec each).
7. In pairs, players pass one touch to each other (give and go) across field and back.
8. Heel stretch.

For details on stretches, please visit [www.soccerpracticebooks.com](http://www.soccerpracticebooks.com)



# Practice Builder



Team: \_\_\_\_\_

Date: \_\_\_\_\_

## Warm-Up

Things to observe: \_\_\_\_\_

\_\_\_\_\_

\_\_\_\_\_

\_\_\_\_\_

Notes: \_\_\_\_\_

\_\_\_\_\_

\_\_\_\_\_

### Warm-Up #5: Dribbling & Shooting (30 min)

1. Dribble ball with changes of direction. Stop ball alternating between sitting on it and putting a knee on it
2. Runner's stretch.
3. Set up as many cones as possible in half field. Players dribble towards cones and body fake left/pass cone right alternating with fake right/pass left.
4. Hamstring stretch.
5. In pairs, players are 10m apart starting 40m from goal. Players pass diagonally to each other and take a shot from top of penalty area (16m).
6. Quad stretch.
7. X2 passes to X1 who turns and shoots. X1 runs to back of line, X2 takes spot of X1.
8. Heel stretch

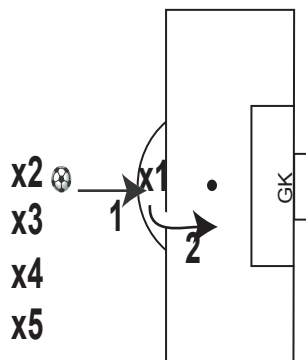

Note: set up two sides and/or several goals depending on number of players. No more than 6 per group, ideal =4



# Practice Builder



Team: \_\_\_\_\_

Date: \_\_\_\_\_

## Warm-Up

Things to observe: \_\_\_\_\_

\_\_\_\_\_

\_\_\_\_\_

\_\_\_\_\_

Notes: \_\_\_\_\_

\_\_\_\_\_

### Warm-Up #6: Dribble, Crossing (30min)

1. Dribble ball with outside of foot. Stop with ball of foot. Take away at right angle with outside of same foot. Keep repeating, alternating feet.
2. Runner's stretch.
3. Dribble and execute scissors move at highest pace to maintain sharp change of direction. If necessary, dribble towards cones and make move.
4. Quad stretch.
5. Groups of three pass the ball to each other down one side of the field. One of the three calls for a final pass to the corner, while the other two make a run to the near and far posts. Player in the corner crosses ball in and players at posts try to score, headers preferred. Group of three now goes across and starts down other side of field. All groups shown should be moving at the same time.
6. Hamstring stretch.
7. Half the players have a ball and are spread out inside penalty area. Players without ball sprint to any player with ball and call for the ball. Ball is thrown to their foot or head and played back with one touch. Players alternate positions every 30 seconds.
8. Heel stretch.

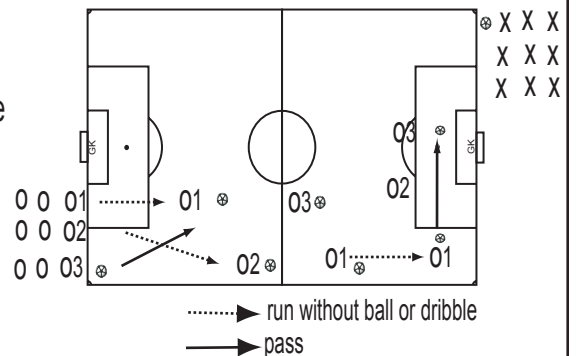



# Practice Builder



Team: \_\_\_\_\_

Date: \_\_\_\_\_

## Warm-Up

Things to observe: \_\_\_\_\_

Notes: \_\_\_\_\_

### Warm-Up #7: Passing (25 min)

1. In pairs, players pass back and forth across the field using two touches on the ball.
2. Runner's stretch.
3. In pairs, players face each other 2m apart. They one-touch pass the ball to each other while increasing the distance between them to 25m. They then decrease the distance while passing back to 2m.
4. Quad stretch.
5. In pairs, facing each other, one-touch pass the ball to each other while shuttling (side stepping) to the half and back.
6. Hamstring stretch.
7. In pairs, one touch pass the ball to each other while moving around half the field twice.
8. Heel stretch.

Note: While these passing drills seem simple, they increase in difficulty if the coach demands 100% accuracy and proper weight and insists on number of touches specified.

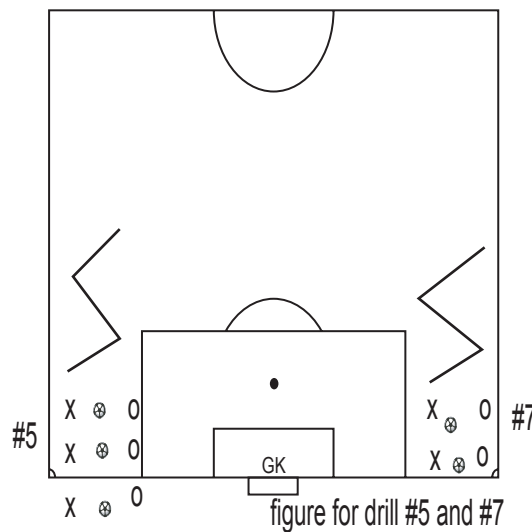



# Practice Builder



Team: \_\_\_\_\_

Date: \_\_\_\_\_

## Warm-Up

Things to observe: \_\_\_\_\_

\_\_\_\_\_

\_\_\_\_\_

\_\_\_\_\_

Notes: \_\_\_\_\_

\_\_\_\_\_

\_\_\_\_\_

### Warm-Up #8: Agility, Ball Control, Fun (30 min)

All drills are in the penalty area.

1. Half of the players have a ball, the other half is spread out in the area, standing with legs apart. Players with ball dribble and pass ball to themselves through the legs of each of the other players. After each player has completed the round, switch roles.
2. Runner's stretch.
3. Same as (1), except players without ball lie on their backs , spread out in the area. Players with ball dribble and chip ball over players lying down. Switch after each player has completed round.
4. Hamstring stretch.
5. Same as (1), except players without ball make an arch with hands extended on ground in front of the body. Players with ball dribble and pass it to themselves through the arch. Switch roles.
6. Quad stretch.
7. Same as (1), except players without ball kneel on hands and knees with head tucked in, to make a very compact "box". Players with ball chip ball over "box". Switch roles.
8. Heel stretch.



# Practice Builder



Team: \_\_\_\_\_

Date: \_\_\_\_\_

## Warm-Up

Things to observe: \_\_\_\_\_

Notes: \_\_\_\_\_

### Warm-Up #9: Circuit (30 min)

1. players dribble ball in square and one at a time leave.
2. dribble through cones
3. lines are hurdles (could be equipment bags, cones) player passes to coach (C) and sprints over hurdles to receive return pass from coach
4. Player passes through small goal and sprints around outside of cone to receive his pass (moving ball)
5. Speed dribble to half way line
6. Dribble around cone to set up shot on goal.

After one circuit, players do runner's stretch,  
 repeat circuit-hamstring stretch, repeat circuit-quad stretch,  
 repeat circuit-heel stretch.

Be sure that players don't leave station 1 too early to  
 avoid jam up in station 2.

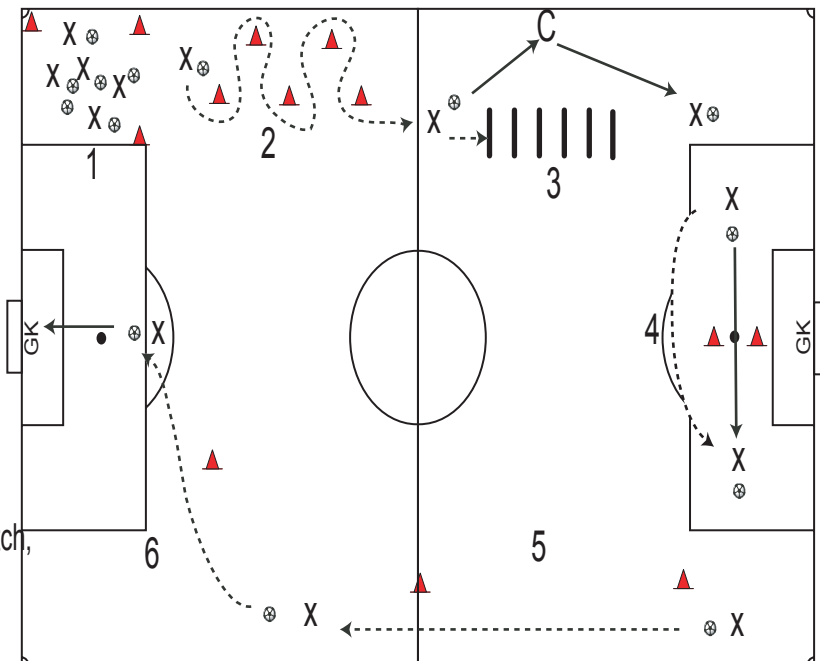



# Practice Builder



Team: \_\_\_\_\_

Date: \_\_\_\_\_

## Warm-Up

Things to observe: \_\_\_\_\_

Notes: \_\_\_\_\_

### Warm-Up #10: Circuit with Passing&Control (30 min)

Work in pairs:

1. one touch passing down sideline
2. one touch passing across field, one player running forward, other runs backwards.
3. two touch passing down sideline
4. X running forward throwing ball to player running backwards who heads it back.

circuit-runner's stretch  
 circuit-hamstring stretch  
 circuit-quad stretch  
 circuit-heel stretch.

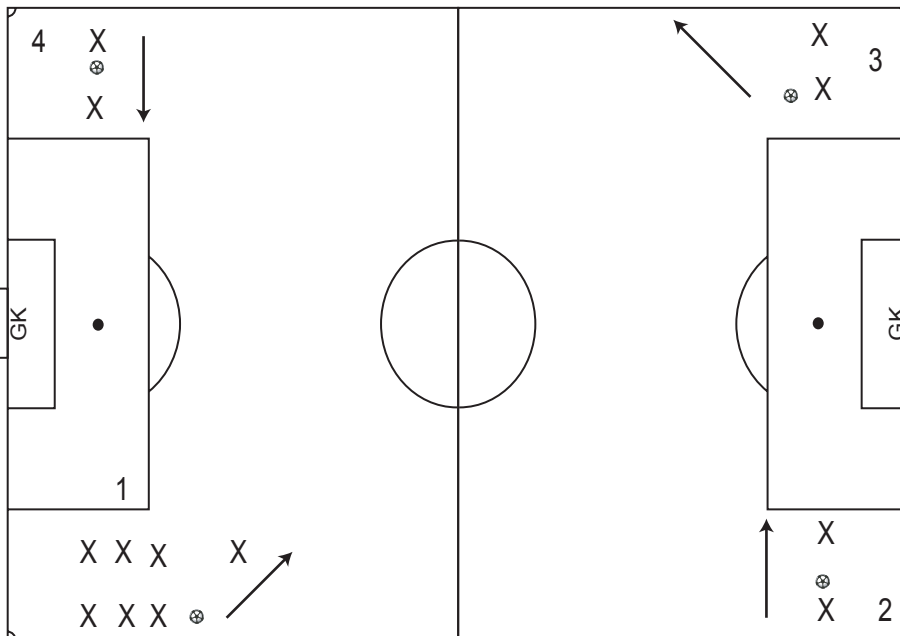

# Youth Competitive Senior Amateur



## Technical Skills



# Practice Builder



Team: \_\_\_\_\_

Date: \_\_\_\_\_

## Technical Skill

Things to observe: \_\_\_\_\_

\_\_\_\_\_

\_\_\_\_\_

\_\_\_\_\_

Notes: \_\_\_\_\_

\_\_\_\_\_

\_\_\_\_\_

### Technical Skill #1: 3 v 2 with shot on goal (20 min.)

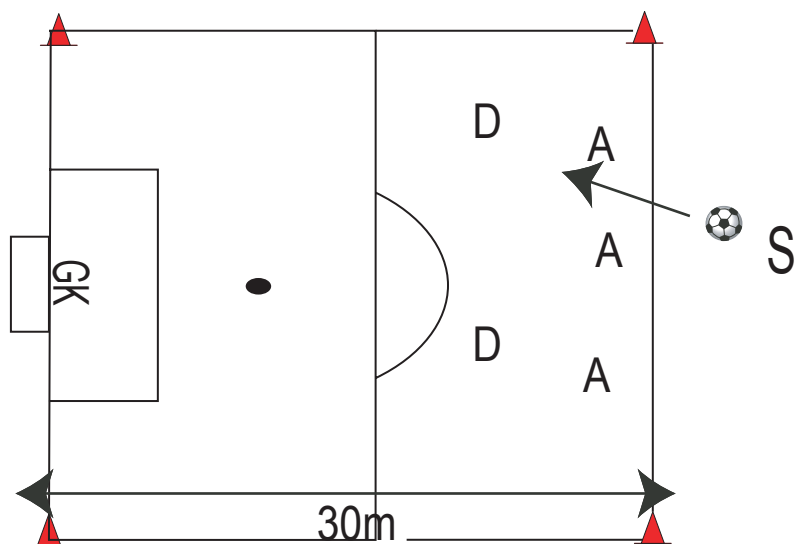

Server plays ball to one of the attackers outside the penalty area.  
 Attackers play 3 v 2 and try to combine to shoot on goal.  
 If defenders win ball, they must play it back to server who restarts play.

You can set this up in two groups or extend size of groups to keep all players occupied.  
 Or, if space is limited, have a second group work on skills and rotate the groups.

Play each game for 5 minutes.



# Practice Builder



Team: \_\_\_\_\_

Date: \_\_\_\_\_

## Technical Skill

Things to observe: \_\_\_\_\_

Notes: \_\_\_\_\_

### Technical Skill #2: 2 v 2 give and go with shot on goal (20 min.)

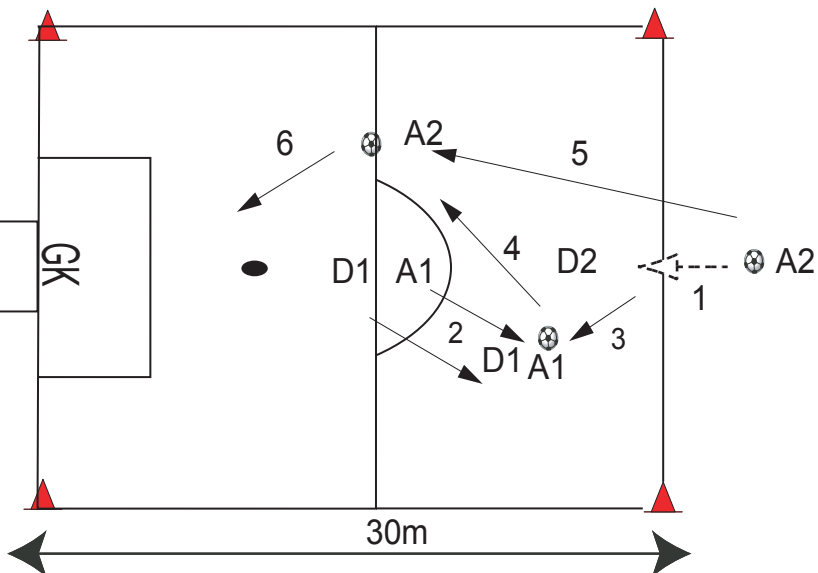

1. A2 dribbles towards D2 who comes towards A2
2. A1 makes a diagonal run behind D2. D1 follows A1.
3. A2 passes to A1.
4. A1 rotates quickly and one touch passes diagonal towards sideline into A2
5. A2 run which is around D2 to the outside
6. A2 should now be clear on net.

This drill will require patience by the coach and players because of the difficulty of the precision required in timing runs and passes.  
Keep trying - when it works in games it is powerful.



# Practice Builder



Team: \_\_\_\_\_

Date: \_\_\_\_\_

## Technical Skill

Things to observe: \_\_\_\_\_

Notes: \_\_\_\_\_

### Technical Skill #3: 1 v 1 shot on goal (20 min.)

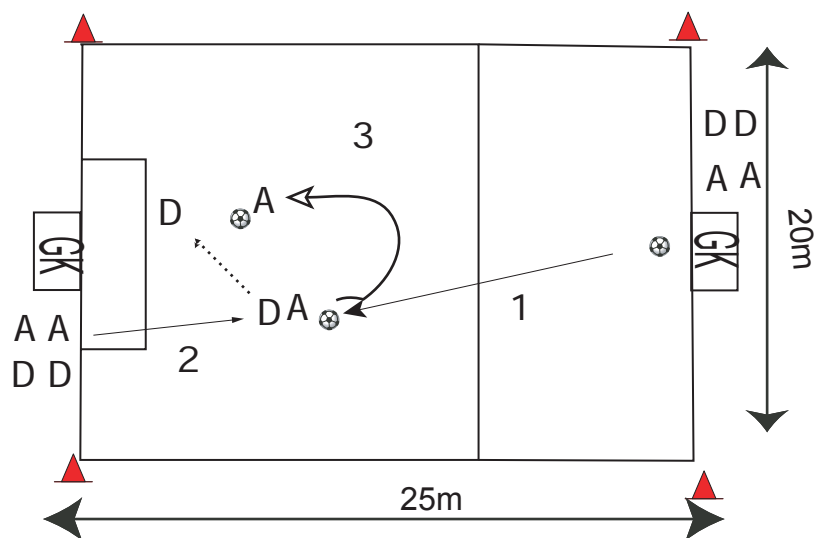

Split team into two groups if possible and set up drill as shown.

1. GK rolls/throws ball to Attacker at opposite goal.
2. Attacker sprints to ball followed by defender.
3. Attacker tries to set up first touch away from defender allowing a turn and to play 1v1.

After attempt at net or stop-play by coach, the play now starts from other end.

Let defender be passive if attackers have no success initially.



# Practice Builder



Team: \_\_\_\_\_

Date: \_\_\_\_\_

## Technical Skill

Things to observe: \_\_\_\_\_

\_\_\_\_\_

\_\_\_\_\_

\_\_\_\_\_

Notes: \_\_\_\_\_

\_\_\_\_\_

\_\_\_\_\_

### Technical Skill #4: Transition Play (25 min.)

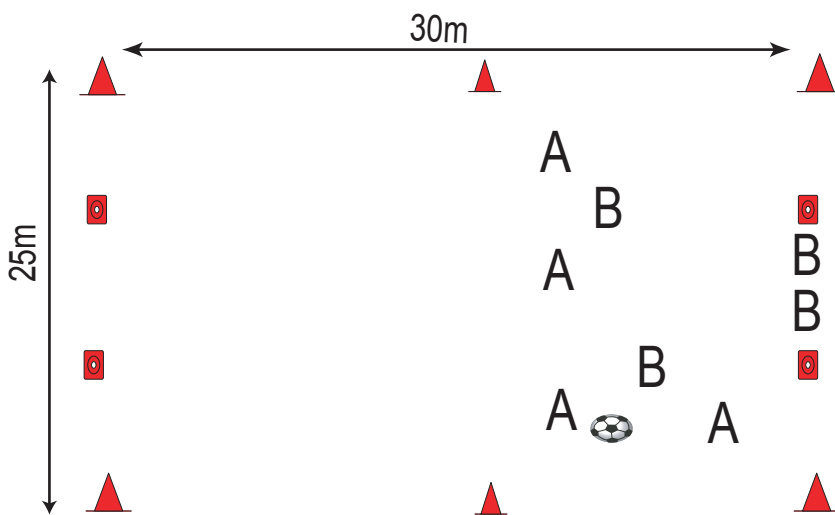

4 v. 4 on two full size goals.

- two defenders (B) must be on goal line before other players (B) can tackle attackers (A).

- after change of possession to defending team (B) or goal, A's must get two players on goal line before other two can tackle the other team (B's).

- meanwhile, attacking team must have all 4 players in other half before they can score.

This drill requires a lot of positive communication, who's on goal line, when, etc.



# Practice Builder



Team: \_\_\_\_\_

Date: \_\_\_\_\_

## Technical Skill

Things to observe: \_\_\_\_\_

Notes: \_\_\_\_\_

### Technical Skill #5: 1 v 1 (15 min)

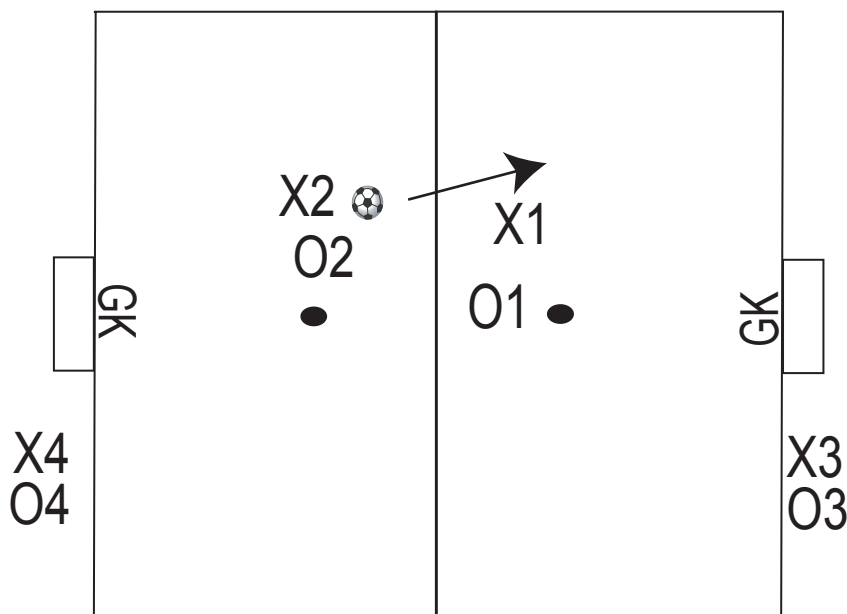

1. X2/O2 and X1/O1 stay in own half.
2. X2 plays ball across half to X1 who plays 1v1 on goal defended by O1.
3. If O1 wins ball or GK takes possession after X1 misses, O1 or GK play ball to O2 in other half.
4. O2 attacks goal defended by X2

X play →

O play ←

X2 and O1 are defenders

X1 and O2 are attackers

Play for 90 sec. and change players with those waiting.  
Set up two fields if number of players permit.



# Practice Builder



Team: \_\_\_\_\_

Date: \_\_\_\_\_

## Technical Skill

Things to observe: \_\_\_\_\_

\_\_\_\_\_

\_\_\_\_\_

\_\_\_\_\_

Notes: \_\_\_\_\_

\_\_\_\_\_

\_\_\_\_\_

### Technical Skill #6: 4v4 flank attack (30 min)

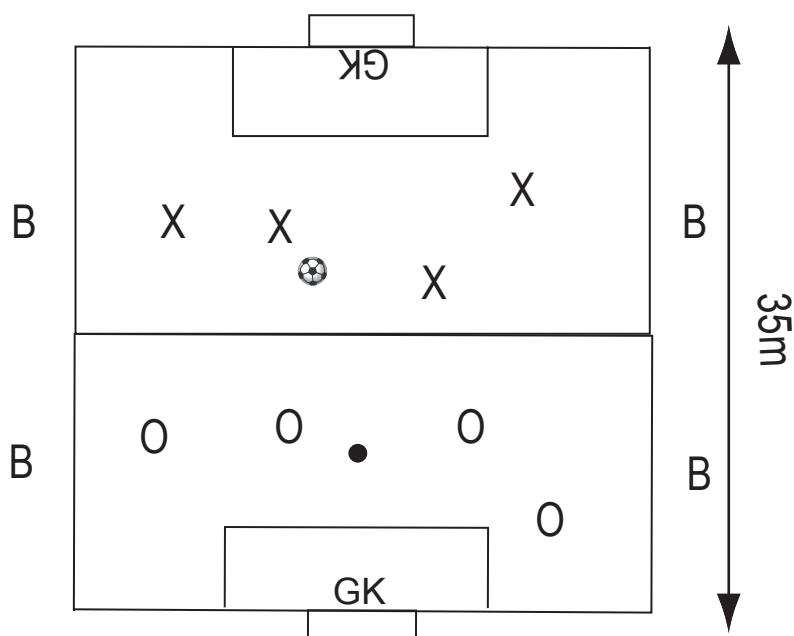

4v4 with 4 neutral players on sidelines. Team in possession can use neutral players.

Quick passes into corners for crosses and finishing.

Rotate teams every 3 minutes.

If there are extra players, make four teams, set up two fields and play without neutrals.



# Practice Builder



Team: \_\_\_\_\_

Date: \_\_\_\_\_

## Technical Skill

Things to observe: \_\_\_\_\_

\_\_\_\_\_

\_\_\_\_\_

\_\_\_\_\_

Notes: \_\_\_\_\_

\_\_\_\_\_

\_\_\_\_\_

### Technical Skill #7: 4 v4 in small area (35 min)

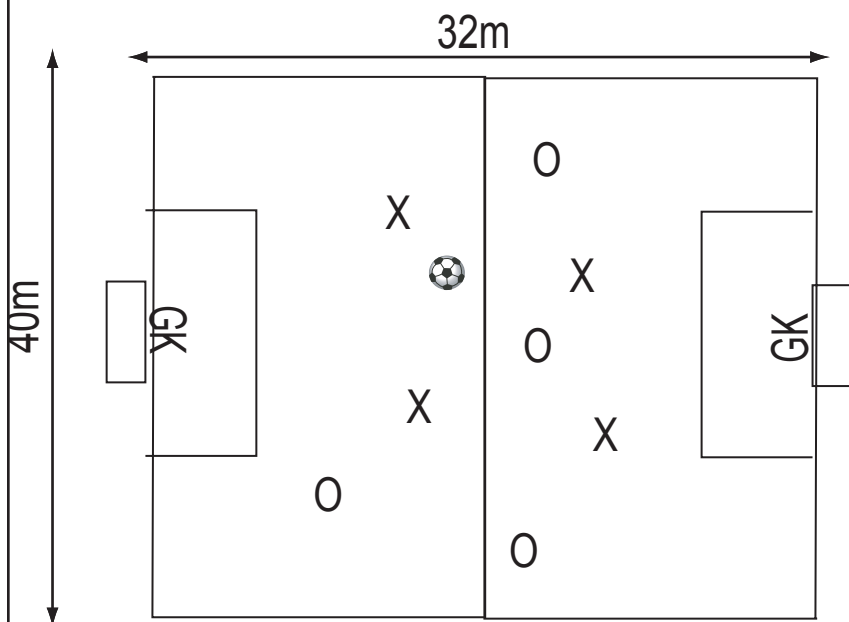

Play 4v4 on full size goals with GK in area twice the size of the penalty area.

X's can score in either goal, but must cross centerline first after scoring a goal or losing possession. After crossing centerline, they can attack either goal again.

6X5 minute games, switching roles of X's and O's

Play on two fields if you have enough players.



# Practice Builder



Team: \_\_\_\_\_

Date: \_\_\_\_\_

## Technical Skill

Things to observe: \_\_\_\_\_

Notes: \_\_\_\_\_

### Technical Skill #8: Two touch shooting (15 min)

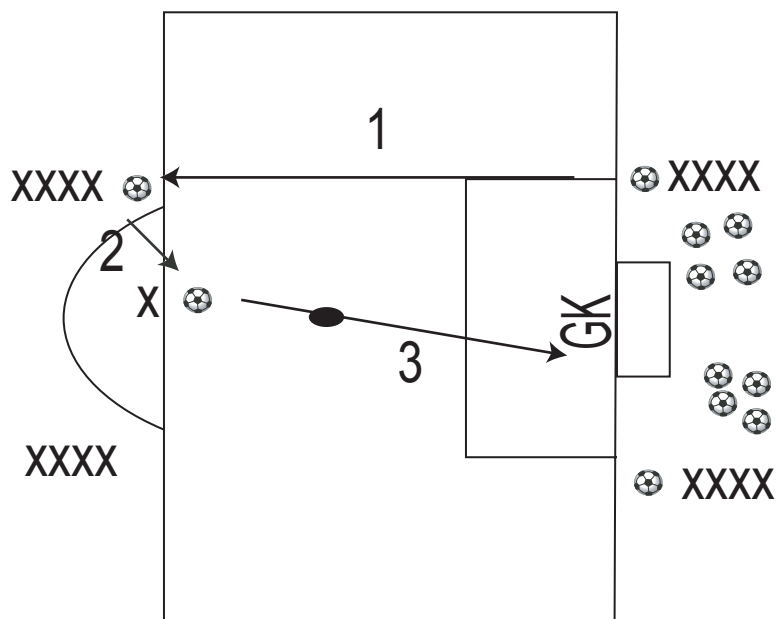

1. Players on goal line play a firm pass out to players waiting at top of penalty area.
2. Players receive ball and set up shot with their first touch, which should be diagonally ahead.
3. On second touch, players take a shot aiming for the far post.

Players passing run to the end of line at top of box.  
 Shooters run to end of passing line.  
 Switch sides after each round.

#### Tips for shooting:

1. Look at target before receiving ball.
2. Keep eye on ball
3. Laces down and ankle locked for shot.



# Practice Builder



Team: \_\_\_\_\_

Date: \_\_\_\_\_

## Technical Skill

Things to observe: \_\_\_\_\_

\_\_\_\_\_

\_\_\_\_\_

\_\_\_\_\_

Notes: \_\_\_\_\_

\_\_\_\_\_

\_\_\_\_\_

### Technical Skill #9: 1v2 Defending (20 min)

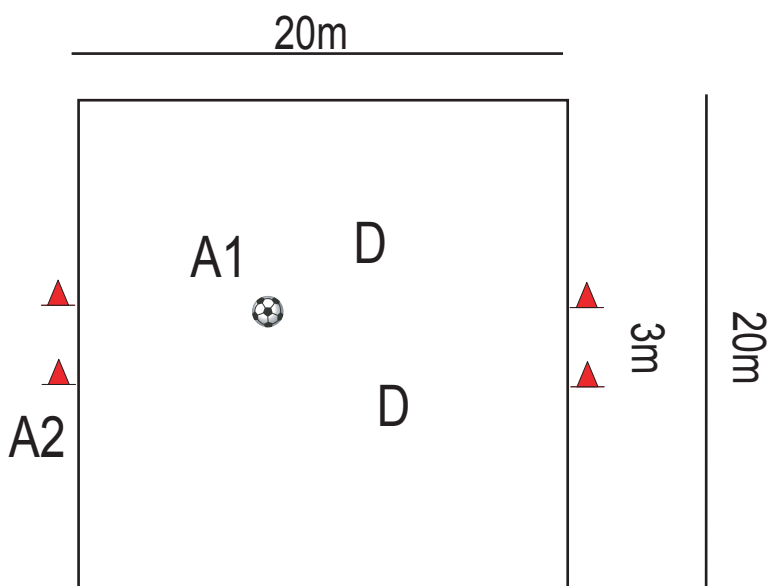

A1 plays 1v2 against D on small goal.  
 A2 waits next to goal players A are defending.  
 A1 can pass to A2 who now plays 1v2,  
 while A1 drops back to goal.

If a D wins ball, D now plays 1v2 against  
 A1/A2 while second D drops back to his goal.

Play 5 x 3 minutes with 1 minute rest  
 between games.

Set up as many playing areas as needed  
 to keep everyone playing



# Practice Builder



Team: \_\_\_\_\_

Date: \_\_\_\_\_

## Technical Skill

Things to observe: \_\_\_\_\_

\_\_\_\_\_

\_\_\_\_\_

\_\_\_\_\_

Notes: \_\_\_\_\_

\_\_\_\_\_

\_\_\_\_\_

### Technical Skill #10: Crossing and 2v1 (15 min)

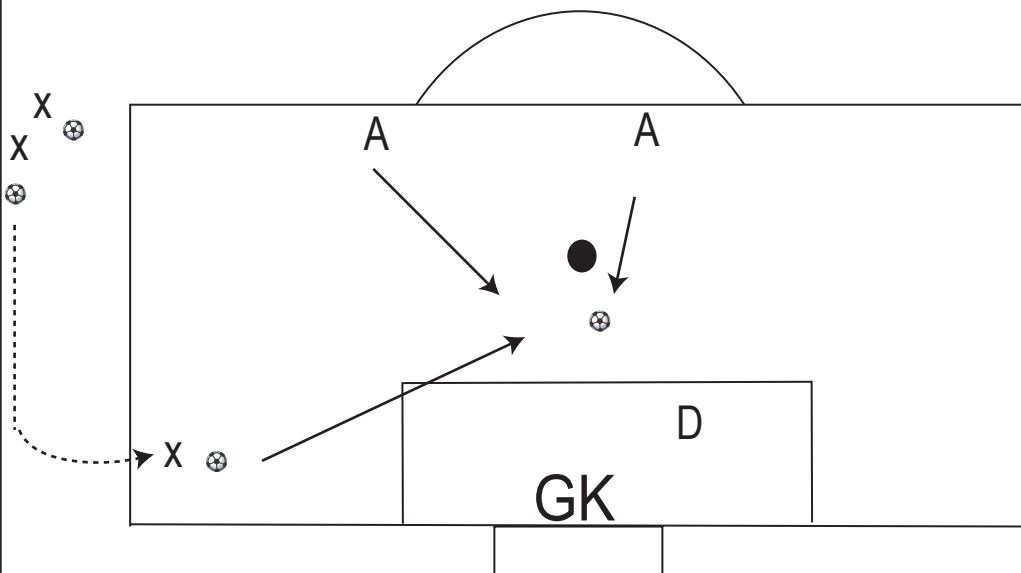

x dribbles outside penalty area and crosses ball in

A play 2v1 v. D on goal. If D touches ball, restart.

Alternate D's.

Set up as many areas and goals as necessary to keep everyone moving.

# Youth Competitive Senior Amateur



## Fitness Drills



# Practice Builder



Team: \_\_\_\_\_

Date: \_\_\_\_\_

## Fitness Focus

Things to observe: \_\_\_\_\_

\_\_\_\_\_

\_\_\_\_\_

\_\_\_\_\_

Notes: \_\_\_\_\_

\_\_\_\_\_

\_\_\_\_\_

### Fitness Focus #1: Pass and Sprint (15 min)

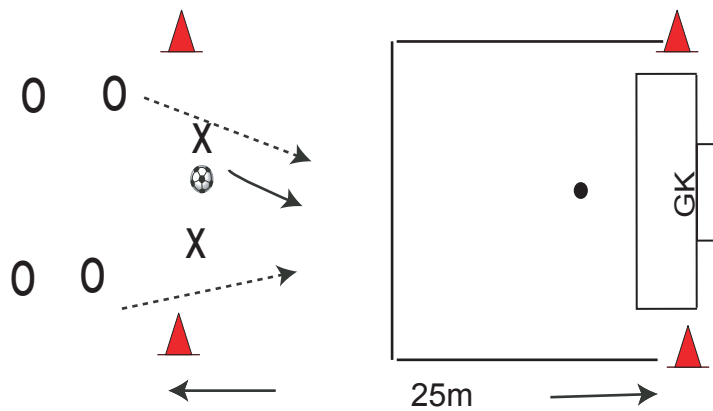

x's pass ball between each other until one of them passes it forward.  
That is command for o's to sprint to ball and play 1 v 1 on goal.



# Practice Builder



Team: \_\_\_\_\_

Date: \_\_\_\_\_

## Fitness Focus

Things to observe: \_\_\_\_\_

\_\_\_\_\_

\_\_\_\_\_

\_\_\_\_\_

Notes: \_\_\_\_\_

\_\_\_\_\_

\_\_\_\_\_

### Fitness Focus #2: 6 v. 3 (15 min)

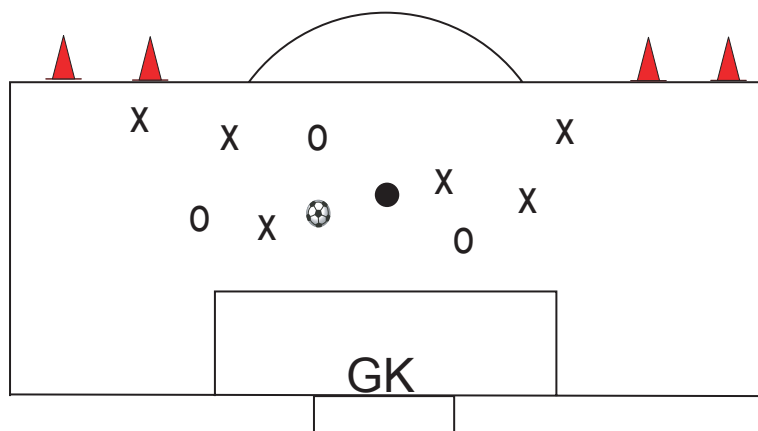

6 x's play two touch and attack large goal.

3 o's defend large goal and try to score into small goals.

Play 3 games of 3 minutes each, rotating everyone through defense

Set up two games if team has enough players.



# Practice Builder



Team: \_\_\_\_\_

Date: \_\_\_\_\_

## Fitness Focus

Things to observe: \_\_\_\_\_

\_\_\_\_\_

\_\_\_\_\_

\_\_\_\_\_

Notes: \_\_\_\_\_

\_\_\_\_\_

\_\_\_\_\_

### Fitness Focus #3: agility/sprint (15 min)

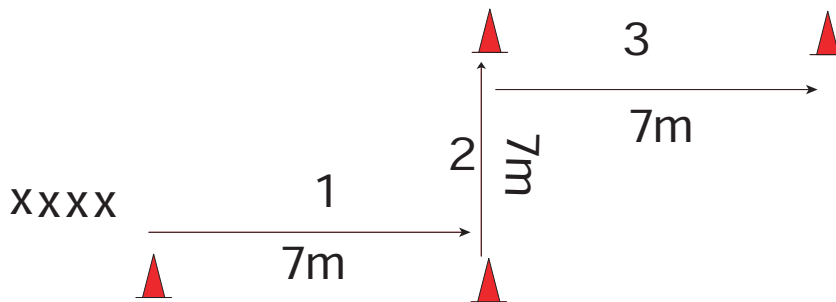

Split team into groups of 3-5 players and set up an exercise area for each group.

1. Two leg (up) hop.
2. Sidestep shuttle run.
3. Explosive forward sprint



# Practice Builder



Team: \_\_\_\_\_

Date: \_\_\_\_\_

## Fitness Focus

Things to observe: \_\_\_\_\_

Notes: \_\_\_\_\_

### Fitness Focus #4: receive-pass-turn

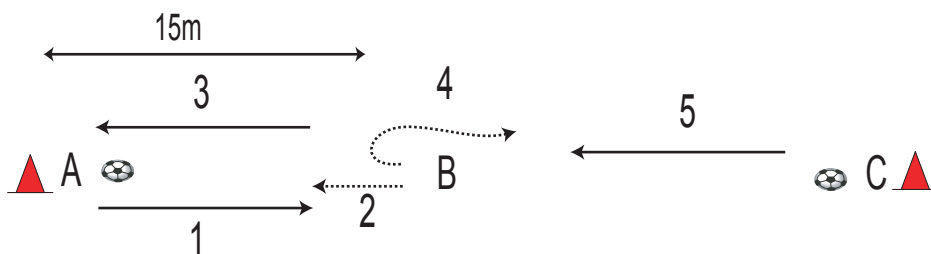

1. A passes to B who
2. attacks ball and
3. one-touch passes it back to A and
4. immediately turns and sprints towards ball
5. passed by C.

Repeat for 3 minutes and rotate through middle position.



# Practice Builder



Team: \_\_\_\_\_

Date: \_\_\_\_\_

## Fitness Focus

Things to observe: \_\_\_\_\_

\_\_\_\_\_  
\_\_\_\_\_  
\_\_\_\_\_

Notes: \_\_\_\_\_

\_\_\_\_\_  
\_\_\_\_\_

### Fitness Focus #5: Reaction Sprint and 1v1

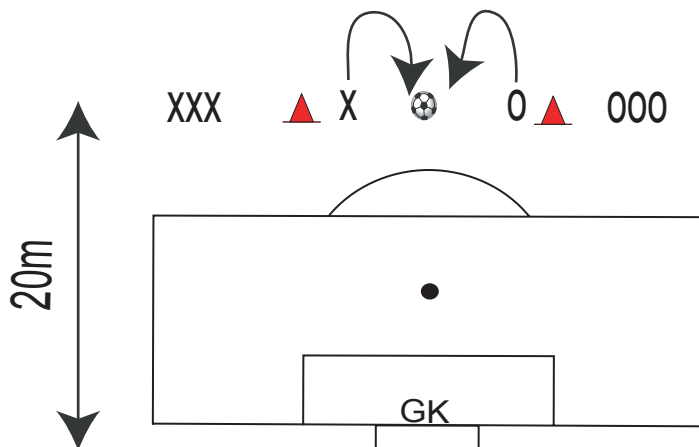

1. x and o face goal and jog backwards away from ball.
2. When x changes direction and sprints to ball, o reacts and also sprints to ball.
3. Now x and o play 1v1 on net.
4. After 1v1, x goes to line of o's waiting and o behind x's.

Note: Set up two or three fields to have no more than 8 players in a group.



# Practice Builder



Team: \_\_\_\_\_

Date: \_\_\_\_\_

## Fitness Focus

Things to observe: \_\_\_\_\_

\_\_\_\_\_

\_\_\_\_\_

\_\_\_\_\_

Notes: \_\_\_\_\_

\_\_\_\_\_

\_\_\_\_\_

### Fitness Focus #6: 3v1 with crossing

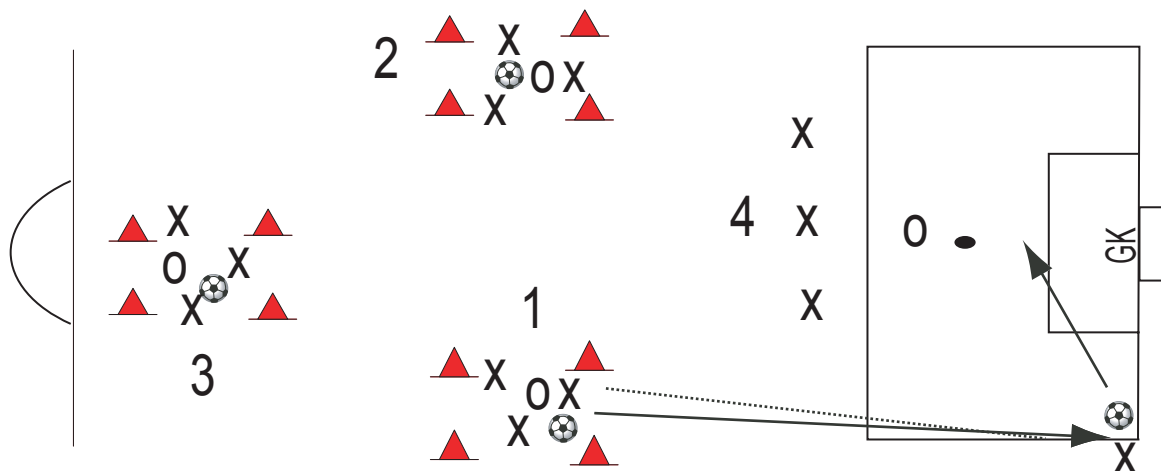

3 groups play 3v1 inside 10mx10m grid

Groups 1 and 2 alternate sending a player to the corner with a pass.

Player crosses to group 4 who plays 3v1 on goal.

Rotate groups every 3 min.



# Practice Builder



Team: \_\_\_\_\_

Date: \_\_\_\_\_

## Fitness Focus

Things to observe: \_\_\_\_\_

\_\_\_\_\_

Notes: \_\_\_\_\_

\_\_\_\_\_

### Fitness Focus #7: sprint and score

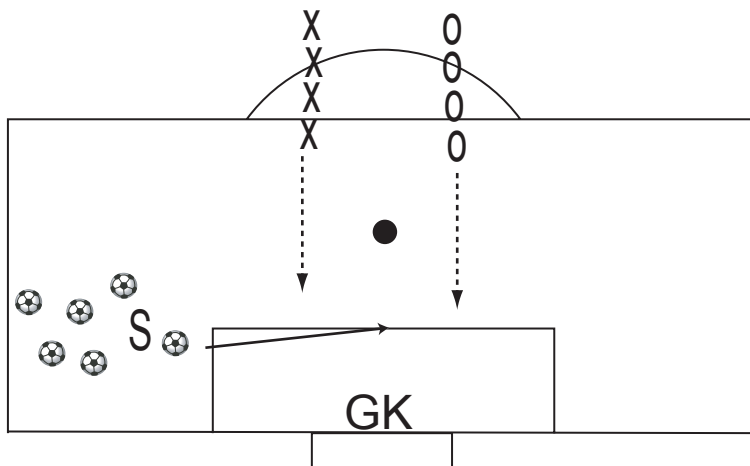

1. Server (S) rolls or throws ball parallel to 5m line.
2. X and O, starting at the top of the penalty area, sprint to ball and try to score. X tries to get to ball on the near side and if X misses, O tries to convert from the far side.
3. Players try to score alternating, based on coach's instruction and throw :
  - a. run and kick,
  - b. run and slide into ball,
  - c. diving header,
  - d. run and head.



# Practice Builder



Team: \_\_\_\_\_

Date: \_\_\_\_\_

## Fitness Focus

Things to observe: \_\_\_\_\_

\_\_\_\_\_

\_\_\_\_\_

\_\_\_\_\_

Notes: \_\_\_\_\_

\_\_\_\_\_

\_\_\_\_\_

### Fitness Focus #8: Dribble and cross

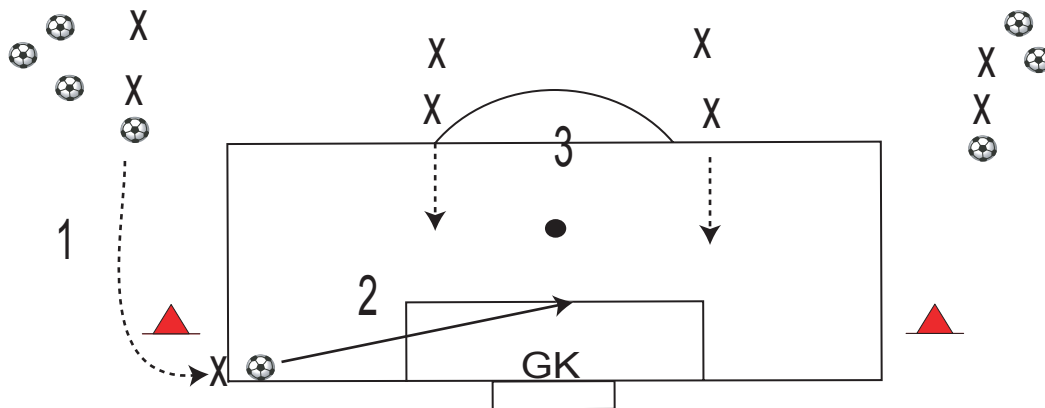

1. X with ball dribbles past cone and
2. Crosses ball outside of 5m line.
3. Players at top of area delay run and once they judge the flight of the ball, sprint in for shot/header.

Players sprint back to their starting position. Alternate sides.

Set up at other goal if number of players is too large to keep drill fast



# Practice Builder



Team: \_\_\_\_\_

Date: \_\_\_\_\_

## Fitness Focus

Things to observe: \_\_\_\_\_

\_\_\_\_\_

\_\_\_\_\_

\_\_\_\_\_

Notes: \_\_\_\_\_

\_\_\_\_\_

\_\_\_\_\_

### Fitness Focus #9: Sprint and 1v1

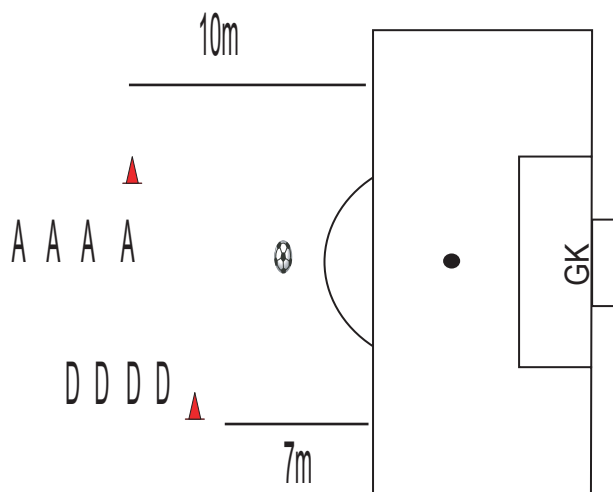

A sprints to ball which is signal for D to sprint to the same ball.  
 First player to touch ball is attacker and plays 1v1 against other player on goal.  
 Sret up enough goals to keep players moving.



# Practice Builder



Team: \_\_\_\_\_

Date: \_\_\_\_\_

## Fitness Focus

Things to observe: \_\_\_\_\_

\_\_\_\_\_

\_\_\_\_\_

Notes: \_\_\_\_\_

\_\_\_\_\_

### Fitness Focus #10: 4v4 in penalty box with crosses

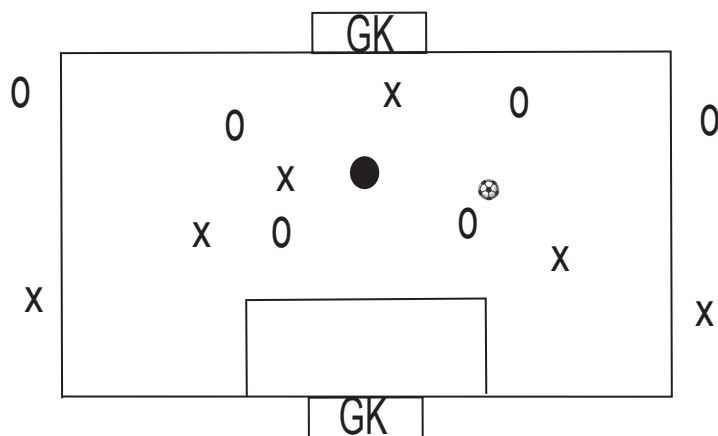

4 v 4 in penalty area, each team attacks opposite goal.

Teams can use players on sideline for crosses. Players on sideline cannot be challenged once they have ball.

3 minute games. Extra players jog around field and get rotated in every three minutes.

# Youth Competitive Senior Amateur



## Tactical Drills



# Practice Builder



Team: \_\_\_\_\_

Date: \_\_\_\_\_

## Tactical Drill

Things to observe: \_\_\_\_\_

\_\_\_\_\_

\_\_\_\_\_

Notes: \_\_\_\_\_

\_\_\_\_\_

\_\_\_\_\_

### Tactical Focus #1: 3 v 3 with target player (20 min)

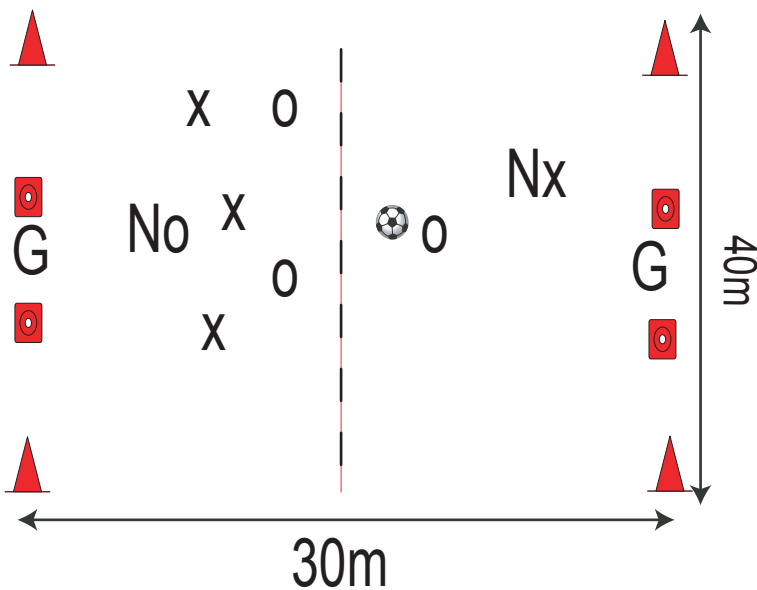

30 x 40 m grid

3 x's vs 3 o's

each team has a target player,  
Nx and No, who stays in other half.

One pt for goal,  
2 pts after give/go w. target player



# Practice Builder



Team: \_\_\_\_\_

Date: \_\_\_\_\_

## Tactical Drill

Things to observe: \_\_\_\_\_

\_\_\_\_\_

\_\_\_\_\_

\_\_\_\_\_

Notes: \_\_\_\_\_

\_\_\_\_\_

\_\_\_\_\_

### Tactical Focus #2: 7 v 7 into four corners (25min)

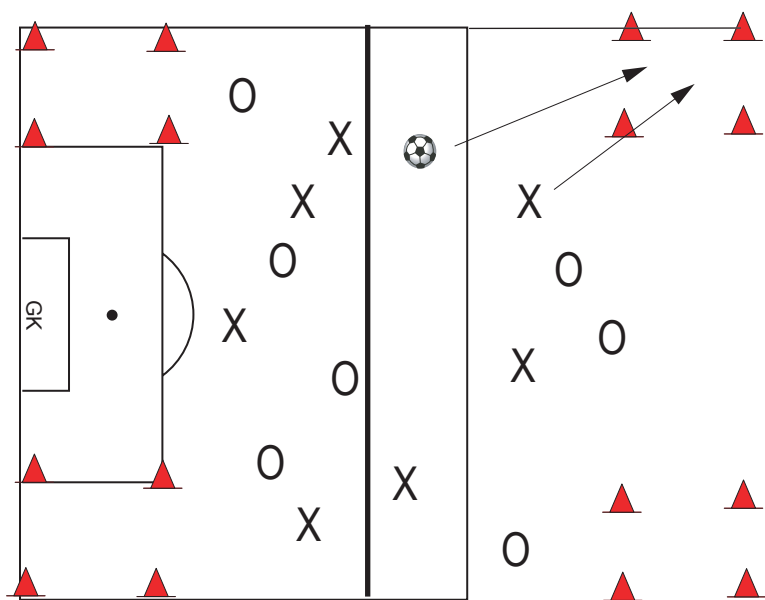

team in possession  
scores point by  
passing to player  
in one of the grids.

After a point, the  
other team gets ball  
and must play  
across half line  
first before scoring.  
Switch sides!!!!!!



# Practice Builder



Team: \_\_\_\_\_

Date: \_\_\_\_\_

## Tactical Drill

Things to observe: \_\_\_\_\_

\_\_\_\_\_

\_\_\_\_\_

\_\_\_\_\_

Notes: \_\_\_\_\_

\_\_\_\_\_

\_\_\_\_\_

### Tactical Focus #3: 4+2 v. 2+4 (25min)

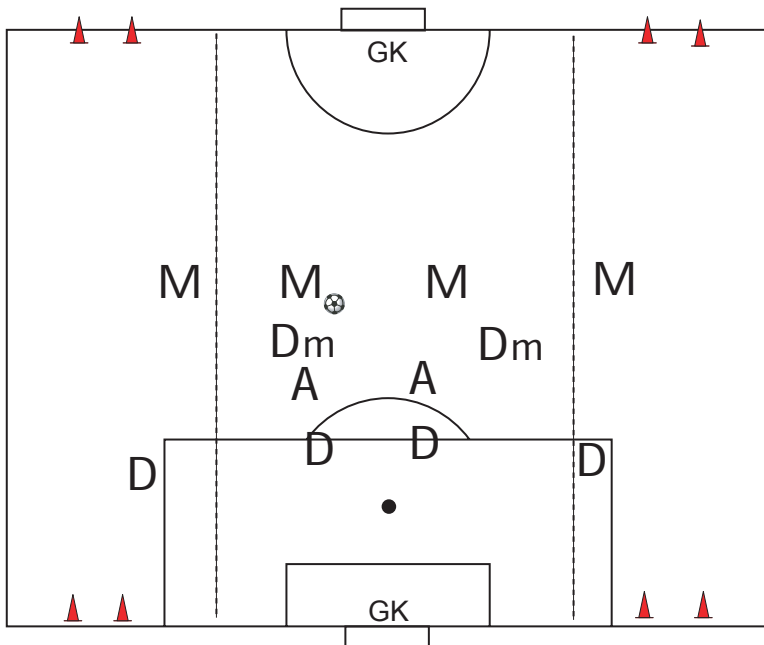

4 midfielders (M) and 2 attackers (A) play v. 4 defenders (D) and 2 defending midf. (Dm).

Field is divided into 3 zones. Goals scored into regular goals = 1p

Goals scored into wide goals while a defender is trapped in far zone = 2pts.



# Practice Builder



Team: \_\_\_\_\_

Date: \_\_\_\_\_

## Tactical Drill

Things to observe: \_\_\_\_\_

\_\_\_\_\_

\_\_\_\_\_

\_\_\_\_\_

Notes: \_\_\_\_\_

\_\_\_\_\_

\_\_\_\_\_

### Tactical Focus #4: 6 v. 4 pressing and counterattack (25min)

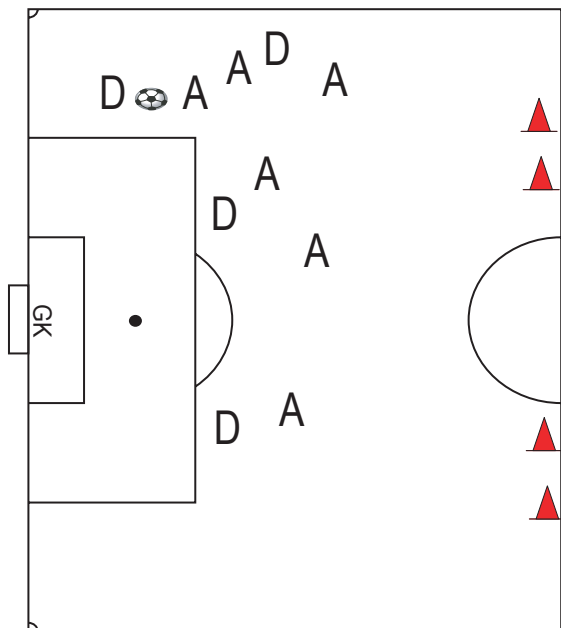

1. Defenders D win ball and try to counterattack on 2 small goals at half.
2. Closest attacker A challenges D with ball and second attacker covers right behind in support.
3. Other attackers close in on ball while taking away passes to other defenders.



# Practice Builder



Team: \_\_\_\_\_

Date: \_\_\_\_\_

## Tactical Drill

Things to observe: \_\_\_\_\_

\_\_\_\_\_

\_\_\_\_\_

\_\_\_\_\_

Notes: \_\_\_\_\_

\_\_\_\_\_

\_\_\_\_\_

### Tactical Focus #5: Transition Play (30 min)

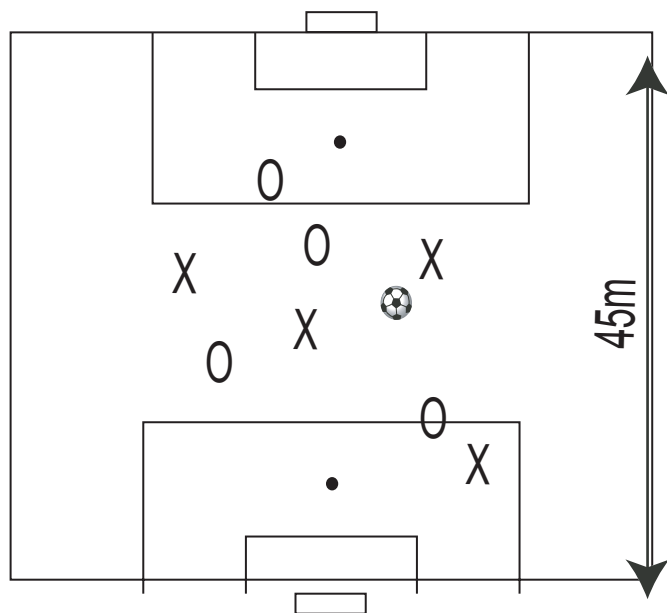

Play 4v4, 5 min. games.  
Teams can score on either goal.

Set up 2 fields if necessary.

Make even number of teams ,  
even if it means playing 4v3, etc  
on one field.

2 min active break after each  
game.



# Practice Builder



Team: \_\_\_\_\_

Date: \_\_\_\_\_

## Tactical Drill

Things to observe: \_\_\_\_\_

\_\_\_\_\_

\_\_\_\_\_

\_\_\_\_\_

Notes: \_\_\_\_\_

\_\_\_\_\_

\_\_\_\_\_

### Tactical Focus #6: 6v6 flank attack (20 min)

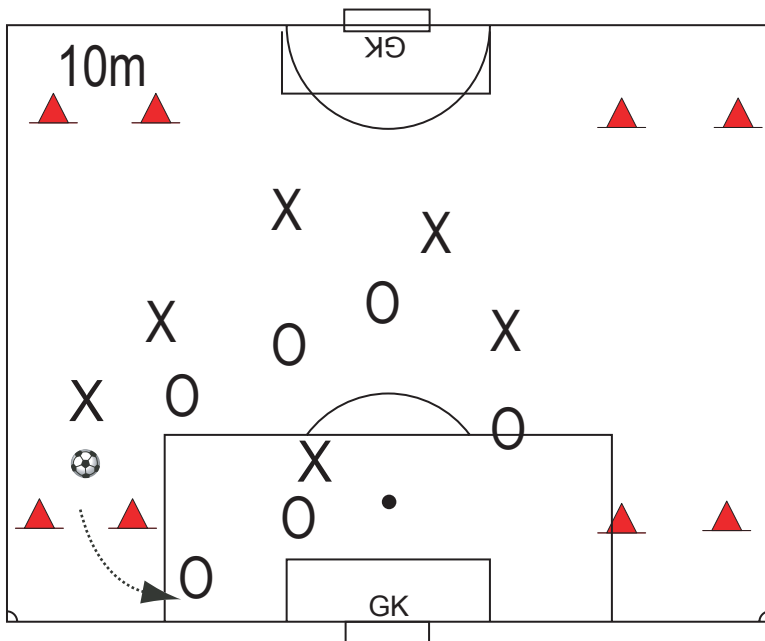

Teams must pass or dribble through cones before they can cross on goal

Substitute extra players as you go



# Practice Builder



Team: \_\_\_\_\_

Date: \_\_\_\_\_

## Tactical Drill

Things to observe: \_\_\_\_\_

\_\_\_\_\_

\_\_\_\_\_

\_\_\_\_\_

Notes: \_\_\_\_\_

\_\_\_\_\_

\_\_\_\_\_

### Tactical Focus #7: 4v4+N crossing (20 min)

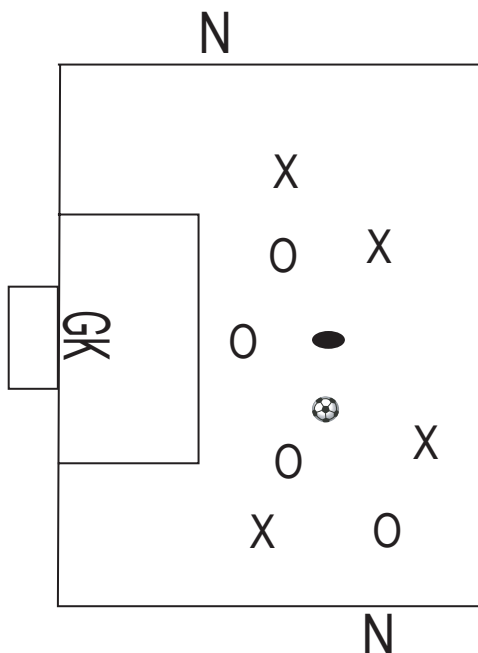

X v O play on one goal inside penalty area.

Team in possession must play to either neutral player who must cross the ball.

Goal can only be scored from a cross by the team that played to N.

If defending team wins ball, they play to N so they can score.

Set up 2 fields or rotate teams of 4.

3 minute games, change N's



# Practice Builder



Team: \_\_\_\_\_

Date: \_\_\_\_\_

## Tactical Drill

Things to observe: \_\_\_\_\_

\_\_\_\_\_

\_\_\_\_\_

\_\_\_\_\_

Notes: \_\_\_\_\_

\_\_\_\_\_

\_\_\_\_\_

### Tactical Focus #8: Crossing (30 min)

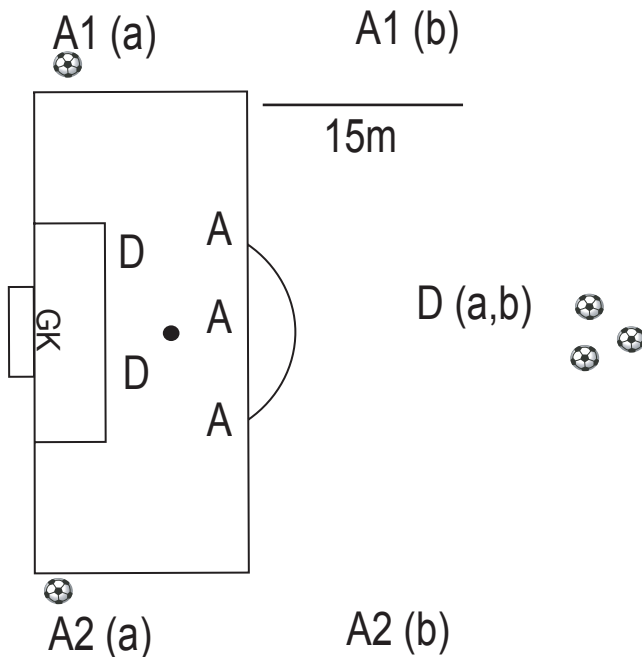

Drill (a):  
 A1 /A2 (a) alternate crosses into box for 3 A's to score v. 2 D's. If D's win ball, they play it out to D (a,b).

Drill (b):  
 D (a,b) passes ball into run of A1 (b) or A2 (b). One of the defenders (D) comes out to challenge A1/2 who must get a cross in.



# Practice Builder



Team: \_\_\_\_\_

Date: \_\_\_\_\_

## Tactical Drill

Things to observe: \_\_\_\_\_

---

---

---

Notes: \_\_\_\_\_

---

---

### Tactical Focus #9: 4 v 3+GK (20 min)

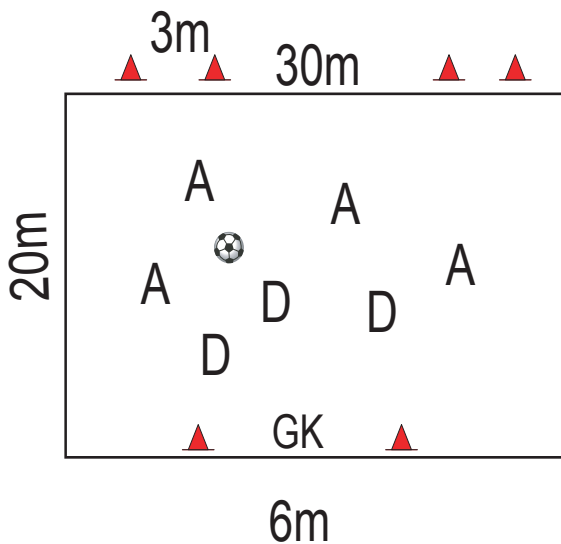

A attack large goal

D attack two small goals

5 X 3 min. games with 1min rests in between.

set up 2 fields



# Practice Builder



Team: \_\_\_\_\_

Date: \_\_\_\_\_

## Tactical Drill

Things to observe: \_\_\_\_\_

\_\_\_\_\_

\_\_\_\_\_

\_\_\_\_\_

Notes: \_\_\_\_\_

\_\_\_\_\_

\_\_\_\_\_

### Tactical Focus #10: 4v4 with 3 groups (25 min)

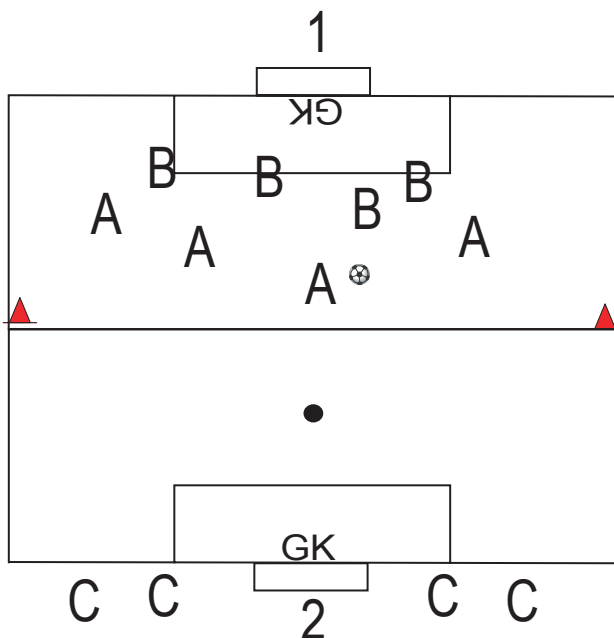

A attacks goal 1 which B defends.

If A scores, game starts again.

If B wins ball, they must cross half-line.

Once B crosses over, C comes out to defend goal 2 which B attacks.

A drops to goal line 1 and waits for C to come across and attack

Youth Competitive  
Senior Amateur

 Practice  
Builder

Scrimmage Focus



# Practice Builder



Team: \_\_\_\_\_

Date: \_\_\_\_\_

## Scrimmage Focus

Things to observe: \_\_\_\_\_

\_\_\_\_\_

\_\_\_\_\_

Notes: \_\_\_\_\_

\_\_\_\_\_

### Scrimmage focus #1: 6 v. 6 - 1/2 field (30 min)

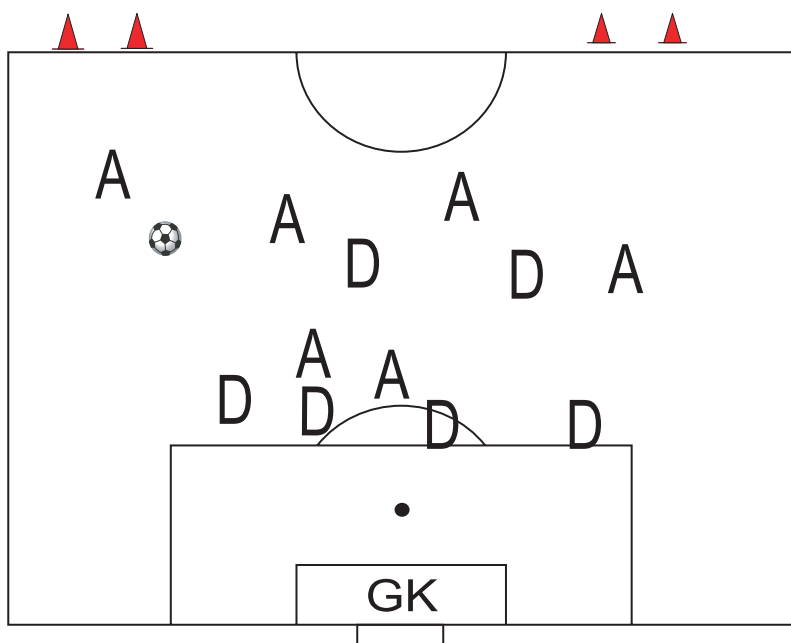

attackers play on goal.  
 defenders counter  
 through small goals  
 players play regular  
 positions  
 10 min. games



# Practice Builder



Team: \_\_\_\_\_

Date: \_\_\_\_\_

## Scrimmage Focus

Things to observe: \_\_\_\_\_

\_\_\_\_\_

\_\_\_\_\_

\_\_\_\_\_

Notes: \_\_\_\_\_

\_\_\_\_\_

\_\_\_\_\_

### Scrimmage focus #2: Flank Attack (30min)

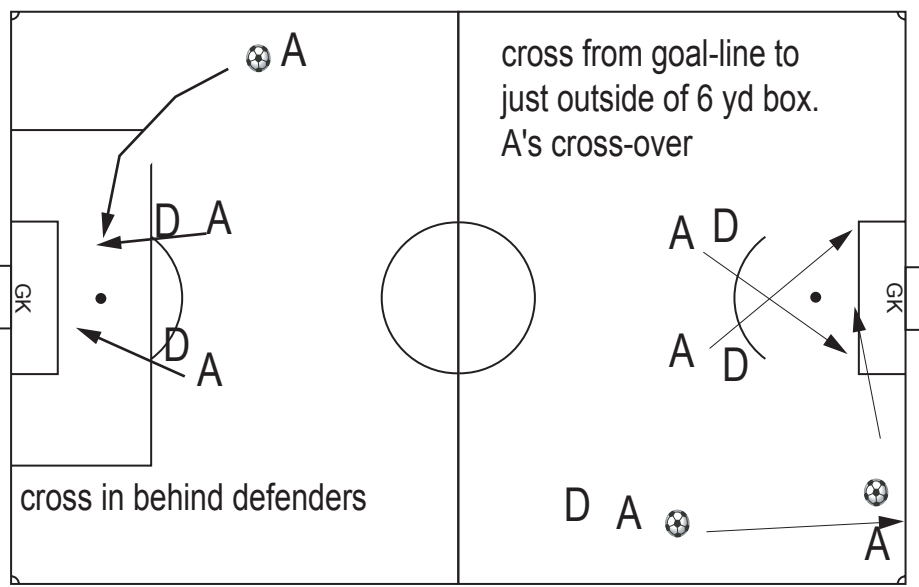

cross from goal-line to just outside of 6 yd box.  
A's cross-over

cross in behind defenders

A must tap ball diagonal towards target before cross



# Practice Builder



Team: \_\_\_\_\_

Date: \_\_\_\_\_

## Scrimmage Focus

Things to observe: \_\_\_\_\_

Notes: \_\_\_\_\_

### Scrimmage focus #3: 1 v 1 defending in 7 v 7 (30min)

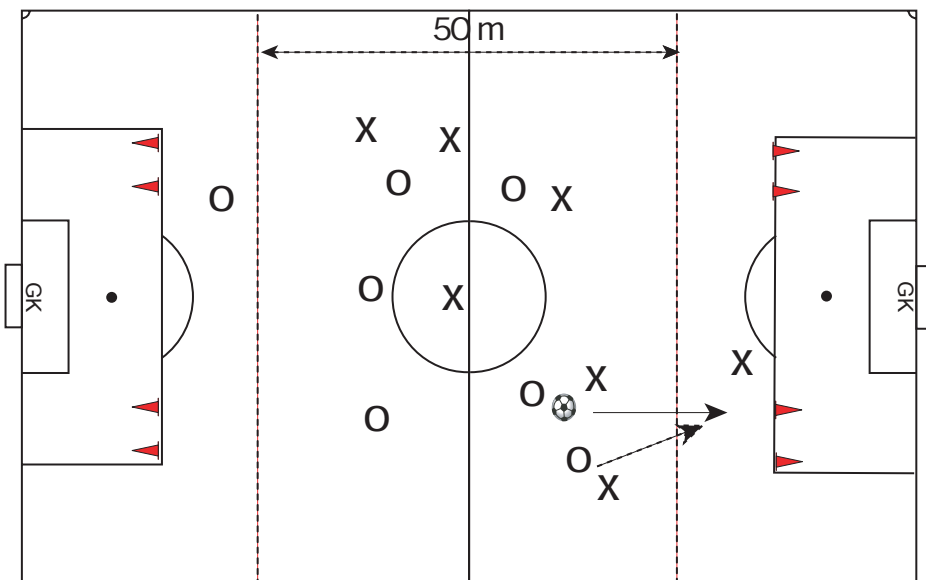

6 v 6 play in 50 m zone. Purpose is to pass deep to player into endzone defended by one defender.

Play is 1 v 1 in endzone on 2 small goals.

After goal is scored or defender wins ball, defender plays it out into 50m zone to his/her team.



# Practice Builder



Team: \_\_\_\_\_

Date: \_\_\_\_\_

## Scrimmage Focus

Things to observe: \_\_\_\_\_

\_\_\_\_\_

\_\_\_\_\_

\_\_\_\_\_

Notes: \_\_\_\_\_

\_\_\_\_\_

\_\_\_\_\_

### Scrimmage focus #4: 7 v. 7 with GK transition play (30min)

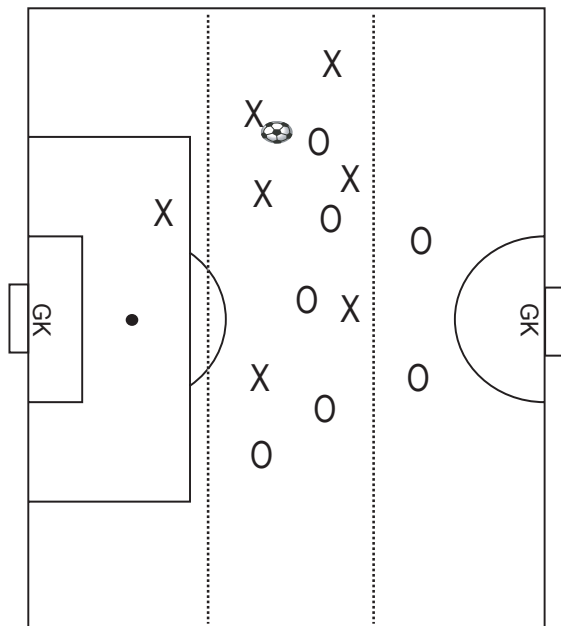

1. divide half field into 3 equal zones.

2. team in possession must have all players at least in middle zone before they can score. (On diagram shown, last X in own third must move up).

3. In own defensive zone, players have to play two-touch until ball is out of defensive zone.

free play in middle and attacking zone.



# Practice Builder



Team: \_\_\_\_\_

Date: \_\_\_\_\_

## Scrimmage Focus

Things to observe: \_\_\_\_\_

\_\_\_\_\_

\_\_\_\_\_

\_\_\_\_\_

Notes: \_\_\_\_\_

\_\_\_\_\_

\_\_\_\_\_

### Scrimmage focus #5: Transition Play (30 min)

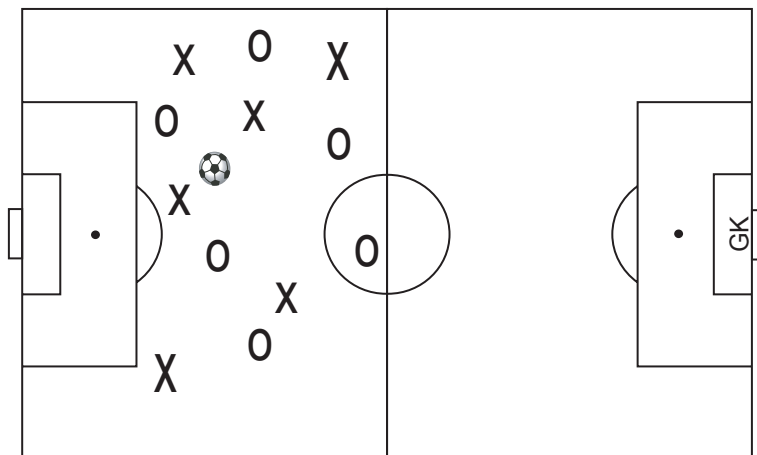

On command by coach, team in possession breaks across half to score.

Other team tries to win ball and score on same goal.

2pts if breaking team scores, 1 pt if defending team scores.

Substitute players on "fly".



# Practice Builder



Team: \_\_\_\_\_

Date: \_\_\_\_\_

## Scrimmage Focus

Things to observe: \_\_\_\_\_

\_\_\_\_\_

\_\_\_\_\_

\_\_\_\_\_

Notes: \_\_\_\_\_

\_\_\_\_\_

\_\_\_\_\_

### Scrimmage focus #6:4v4&3v2 (25 min)

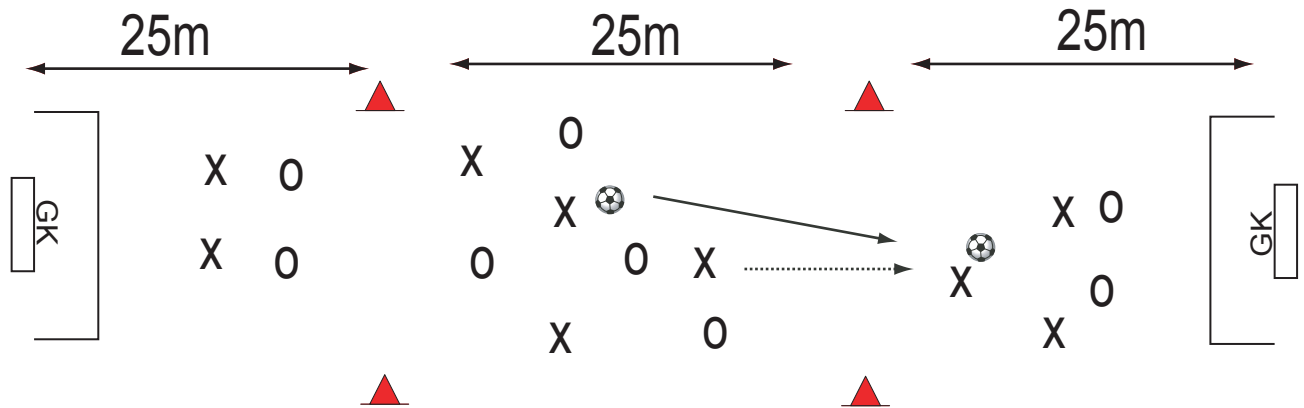

Full width of field is divided into 3x25m long sections.

4v4 in middle section: team in possession tries to send a player into one end section for a 3v2 on goal. Restart in middle



# Practice Builder



Team: \_\_\_\_\_

Date: \_\_\_\_\_

## Scrimmage Focus

Things to observe: \_\_\_\_\_

\_\_\_\_\_

\_\_\_\_\_

\_\_\_\_\_

Notes: \_\_\_\_\_

\_\_\_\_\_

\_\_\_\_\_

### Scrimmage focus #7: 7v7 Flank attack (25 min)

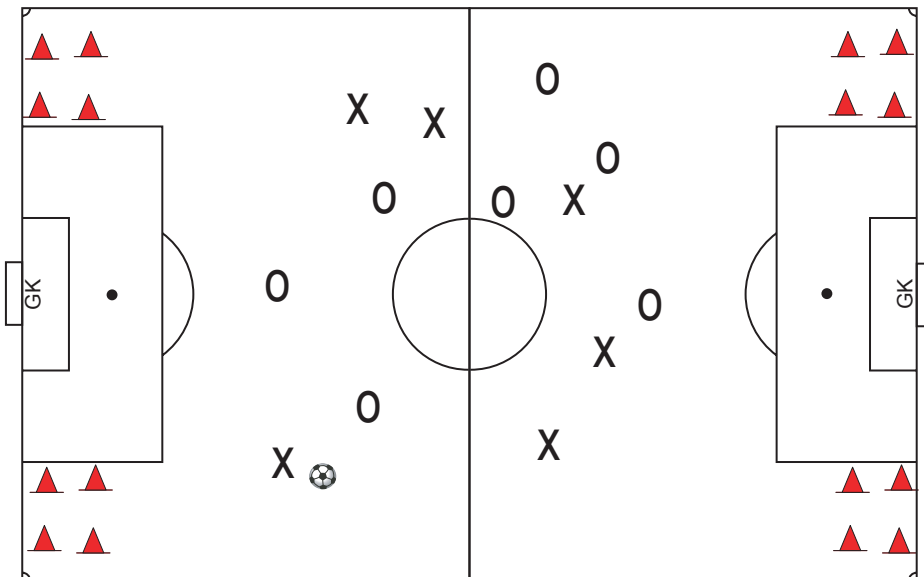

X v O, full field.

Both teams can score on either goal after playing to a teammate in one of the corner squares.

In square, player can not be challenged.

Teams must play across center-field before they can score again.



# Practice Builder



Team: \_\_\_\_\_

Date: \_\_\_\_\_

## Scrimmage Focus

Things to observe: \_\_\_\_\_

\_\_\_\_\_

\_\_\_\_\_

\_\_\_\_\_

Notes: \_\_\_\_\_

\_\_\_\_\_

\_\_\_\_\_

### Scrimmage focus #8: 7v7 with crossing (30 min.)

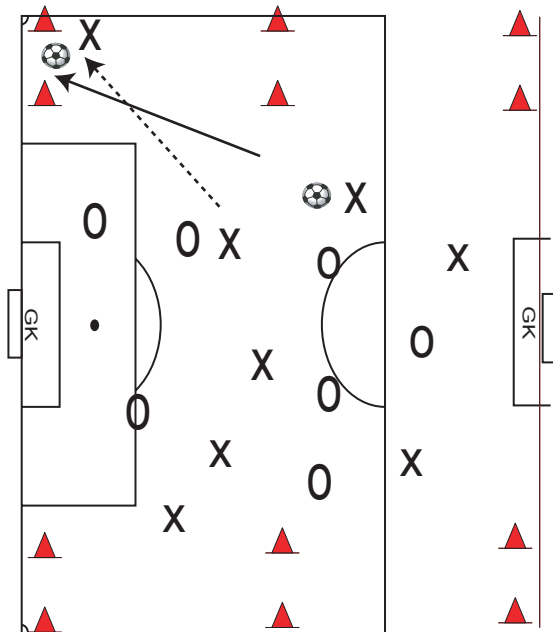

7 v 7 play 3 touch max. per player in the marked field.

The cones on either side mark a "free crossing" lane.

A player receiving a ball in free lane cannot be challenged and gets a free cross on goal.

Goals scored from crosses count as 2 points. Regular goal counts as 1 pt.

Make sure teams mix up playing for crosses and through middle.



# Practice Builder



Team: \_\_\_\_\_

Date: \_\_\_\_\_

## Scrimmage Focus

Things to observe: \_\_\_\_\_

\_\_\_\_\_

Notes: \_\_\_\_\_

\_\_\_\_\_

### Scrimmage focus #9: 8v8 (30 min.)

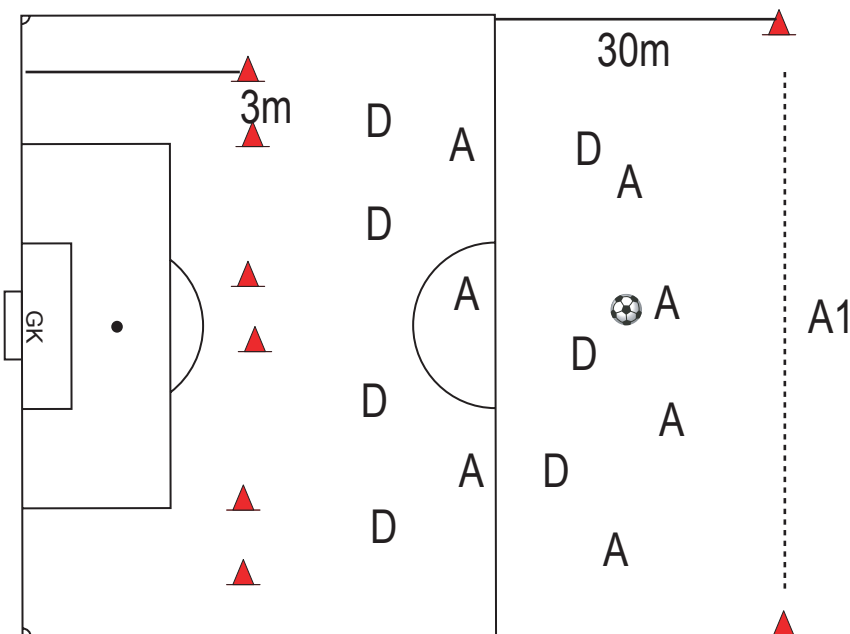

Attackers (A) must dribble through small goal to score.

They can not be challenged after they pass through small goal.

If defenders (D) win ball, they play it to A1 who waits in neutral zone and restarts attack.



# Practice Builder



Team: \_\_\_\_\_

Date: \_\_\_\_\_

## Scrimmage Focus

Things to observe: \_\_\_\_\_

\_\_\_\_\_

\_\_\_\_\_

\_\_\_\_\_

Notes: \_\_\_\_\_

\_\_\_\_\_

\_\_\_\_\_

### Scrimmage focus #10: 5v4 (30 min)

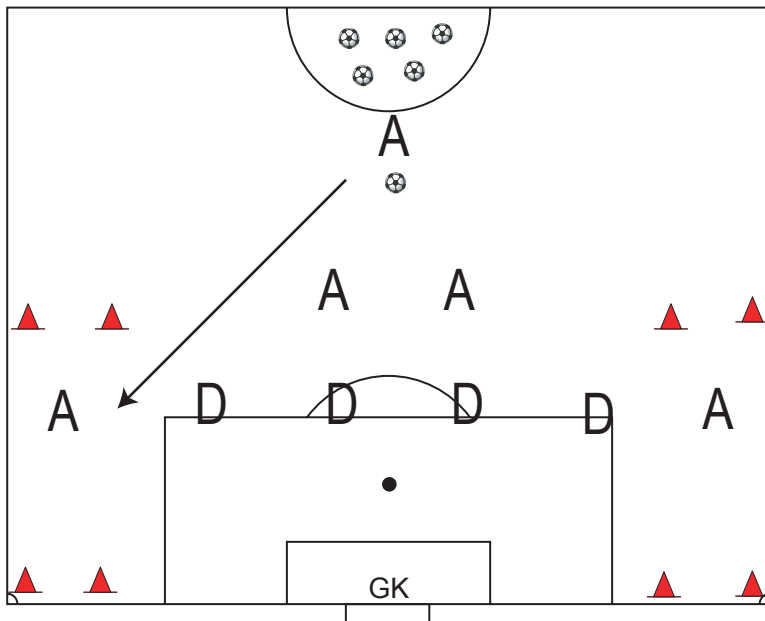

A passes ball to one of A's in a side-zone.  
 Once A receives ball, D's can challenge.  
 A's now play 5v4 on goal.

If Ds win ball they clear it out and A restarts.

After goal, A restarts.

Set up two fields or substitute players in.