



Adobe

Inspiration becomes reality.™

[www.adobe.com](http://www.adobe.com)

```
document.write("<HTML HEAD EQUIV="content-type" C  
META NAME="generator" CONTENT="A  
Adobe Systems Incorporated  
LANGUAGE="JavaScript"><!--  
currentSection = "sitemenu";  
lastOver;  
var preloadflag = false;  
worldwidePopped = false;  
var worldwideTimer;  
  
if (navigator.platform && (navigator.  
//mac users  
document.write('<LINK HREF="/ssi
```

# Introduction to XML

## A little about PDF

*James C. King*  
*A Principal Scientist*  
*Advanced Technology Group*  
*Adobe Systems Incorporated*



# Contents

- **First: XML and Markup**
  - *Markup Languages*
  - *XML Markup Languages*
  - *Processing Markup*
- **Second: PDF**
  - *Role in Markup Processing*

# HTML

- HTML is a “markup language”
  - *“Hypertext Markup Language”*

# Plain Text (Lincoln's E-Mail)

To: Edward Everett

From: Abraham Lincoln

Subject: FYI--President's Official Dedication to be Delivered After  
Your Oration

Date: November 18, 1863

Four score and seven years ago our fathers brought forth on this continent, a new nation, conceived in Liberty, and dedicated to the proposition that all men are created equal.

Now we are engaged in a great civil war, testing whether that nation, or any nation so conceived and so dedicated, can long endure. We are met on a great battle-field of that war. We have come to dedicate a portion of that field, as a final resting place for those who here gave their lives that that nation might live. It is altogether fitting and proper that we should do this.

# Plain Text (Lincoln's E-Mail)

But, in a larger sense, we can not dedicate—we can not consecrate – we can not hallow – this ground. The brave men, living and dead, who struggled here, have consecrated it, far above our poor power to add or detract. The world will little note, nor long remember

what we say here, but it can never forget what they did here. It is for us the living, rather, to be dedicated here to the unfinished work which they who fought here have thus far so nobly advanced. It is rather for us to be here dedicated to the great task remaining before us—that from these honored dead we take increased devotion to that cause for which they gave the last full measure of devotion—that we here highly resolve that these dead shall not have died in vain—that this nation, under God, shall have a new birth of freedom—and that government of the people, by the people, for the people, shall not perish from the earth.

November 19, 1863. Abraham Lincoln.

To: Edward Everett  
From: Abraham Lincoln  
Subject: FYI--President's Official Dedication to be Delivered After Your Oration  
Date: November 18, 1863

Four score and seven years ago our fathers brought forth on this continent, a new nation, conceived in Liberty, and dedicated to the proposition that all men are created equal.

Now we are engaged in a great civil war, testing whether that nation, or any nation so conceived and so dedicated, can long endure. We are met on a great battle-field of that war. We have come to dedicate a portion of that field, as a final resting place for those who here gave their lives that that nation might live. It is altogether fitting and proper that we should do this.

But, in a larger sense, we can not dedicate--we can not consecrate--we can not hallow--this ground. The brave men, living and dead, who struggled here, have consecrated it, far above our poor power to add or detract. The world will little note, nor long remember what we say here, but it can never forget what they did here. It is for us the living, rather, to be dedicated here to the unfinished work which they who fought here have thus far so nobly advanced. It is rather for us to be here dedicated to the great task remaining before us--that from these honored dead we take increased devotion to that cause for which they gave the last full measure of devotion--that we here highly resolve that these dead shall not have died in vain--that this nation, under God, shall have a new birth of freedom--and that government of the people, by the people, for the people shall not perish from the earth.

November 19, 1863. Abraham Lincoln.



To: Edward Everett  
From: Abraham Lincoln  
Subject: FYI--President's Official Dedication to be Delivered After Your Oration  
Date: November 18, 1863

---

**F**our score and seven years ago our fathers brought forth on this continent, a new nation, conceived in Liberty, and dedicated to the proposition that all men are created equal.

**N**ow we are engaged in a great civil war, testing whether that nation, or any nation so conceived and so dedicated, can long endure. We are met on a great battle-field of that war. We have come to dedicate a portion of that field, as a final resting place for those who here gave their lives that that nation might live. It is altogether fitting and proper that we should do this.

**B**ut, in a larger sense, we can not dedicate--we can not consecrate--we can not hallow--this ground. The brave men, living and dead, who struggled here, have consecrated it, far above our poor power to add or detract. The world will little note, nor long remember what we say here, but it can never forget what they did here. It is for us the living, rather, to be dedicated here to the unfinished work which they who fought here have thus far so nobly advanced. It is rather for us to be here dedicated to the great task remaining before us--that from these honored dead we take increased devotion to that cause for which they gave the last full measure of devotion--that we here highly resolve that these dead shall not have died in vain--that this nation, under God, shall have a new birth of freedom--and that government of the people, by the people, for the people shall not perish from the earth.

November 19, 1863. Abraham Lincoln.

# Marked-Up Text (Lincoln's E-Mail)

```
<html>
<body bgcolor="#FFFFFF">
  
  <font style="font-family:'AdobeCorpID-MyriadRg'; font-size:'2';">
  <table>
    <tr><td height="80" width="15%" valign="bottom">
      <font style="font-style:italic; color:#0055ff">To:</font></td>
      <td valign="bottom"><font style="color:#808080">Edward
        Everett</font></td>
    </tr><tr><td>
      <font style="font-style:italic; color:#0055ff">From:</font></td>
      <td><font style="color:#808080">Abraham Lincoln</font></td>
    </tr><tr><td valign="top">
      <font style="font-style:italic;color:#0055ff">Subject:</font></td>
      <td><font style="color:#808080">FYI--President's Official
        Dedication to be Delivered After Your Oration</font></td>
    </tr>
```

# Marked-Up Text (Lincoln's E-Mail)

```
<tr><td>
```

```
<font style="font-style:italic; color:#0055ff">Date:</font></td>
```

```
<td><font style="color:#808080">November 18,
```

```
1863</font></td>
```

```
</tr>
```

```
</table>
```

```
</font>
```

```
<hr/>
```

```
<p>
```

```
<font style="font-family:'AdobeCorpID-MinionRg';">
```

```
<font size="5" color="red">F</font>our score and seven years ago
```

```
our fathers brought forth on this continent, a new nation,
```

```
conceived in Liberty, and dedicated to the proposition that all men
```

```
are created equal.
```

```
</font></p>
```

# Marked-Up Text (Lincoln's E-Mail)

<p><font style="font-family:'AdobeCorpID-MinionRg';">

<font size="5" color="red">N</font>ow we are engaged in a great civil war, testing whether that nation, or any nation so conceived and so dedicated, can long endure. We are met on a great battle-field of that war. We have come to dedicate a portion of that field, as a final resting place for those who here gave their lives that that nation might live. It is altogether fitting and proper that we should do this.

</font></p>

<p><font style="font-family:'AdobeCorpID-MinionRg';">

<font size="5" color="red">B</font>ut, in a larger sense, we can not dedicate--we can not consecrate--we can not hallow--this ground. The brave men, living and dead, who struggled here, have consecrated it, far above our poor power to add or detract. The world will little note, nor long remember what we say here, but it can never forget what they did here. It is for us the living, rather, to be dedicated here to the unfinished work which they who fought

# Marked-Up Text (Lincoln's E-Mail)

here have thus far so nobly advanced. It is rather for us to be here dedicated to the great task remaining before us--that from these honored dead we take increased devotion to that cause for which they gave the last full measure of devotion--that we here highly resolve that these dead shall not have died in vain--that this nation, under God, shall have a new birth of freedom--and that government of the people, by the people, for the people shall not perish from the earth.

</font></p><p>

<font style="font-family:'AdobeCorpID-MinionRg';">

November 19, 1863. Abraham Lincoln.

</font></p>

</body>

</html>

# XML

- HTML is a “markup language”
- XML is NOT a “markup language”
  - *In spite of what the name says:*  
“*Extensible Markup Language*”

# XML

- **XML is a standardized way to create Markup Languages**
  - *many, many markup languages*
- **Follow the XML rules – you get:**
  - *Very well defined and documented rules*
  - *Common tools widely available*
  - *Common knowledge and understanding*
  - ***Selective** word search on any text portion*

# XML Markup Languages

- **XML for Business Cards**
  - *XML basics: elements and attributes*
  - *DOM (Document Object Model)*
- **Standard XML Markup Languages**
- **XML for HTML**

# XML for Business Cards

## ■ Markup Language for Business Cards (my own invention)

```
<businesscard>
  <name sex="M" suffix="Jr." >Joe Smith</name>
  <title>Principal Scientist</title>
  <company>
    <name>Adobe Systems Incorporated</name>
    <address>345 Park Avenue</address>
    <address>San Jose, Ca 95110-2704</address>
    <phone> (408) 536-6000</phone>
    <fax> (408) 537-4042</fax>
  </company>
  <email>jsmith@adobe.com</email>
</businesscard>
```

# XML for Business Cards

## An Element

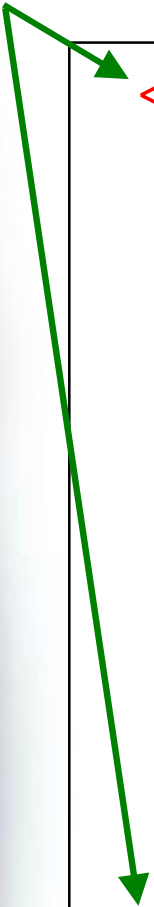

```
<businesscard>  
  <name sex="M" suffix="Jr." >Joe Smith</name>  
  <title>Principal Scientist</title>  
  <company>  
    <name>Adobe Systems Incorporated</name>  
    <address>345 Park Avenue</address>  
    <address>San Jose, Ca 95110-2704</address>  
    <phone> (408) 536-6000</phone>  
    <fax> (408) 537-4042</fax>  
  </company>  
  <email>jsmith@adobe.com</email>  
</businesscard>
```

# XML for Business Cards

## An Element

```
<businesscard>
  <name sex="M" suffix="Jr." >Joe Smith</name>
  <title>Principal Scientist</title>
  <company>
    <name>Adobe Systems Incorporated</name>
    <address>345 Park Avenue</address>
    <address>San Jose, Ca 95110-2704</address>
    <phone> (408) 536-6000</phone>
    <fax> (408) 537-4042</fax>
  </company>
  <email>jsmith@adobe.com</email>
</businesscard>
```

# XML for Business Cards

*An Element*

*Element Contents*

```
<businesscard>  
  <name sex="M" suffix="Jr." >Joe Smith</name>  
  <title>Principal Scientist</title>  
  <company>  
    <name>Adobe Systems Incorporated</name>  
    <address>345 Park Avenue</address>  
    <address>San Jose, Ca 95110-2704</address>  
    <phone> (408) 536-6000</phone>  
    <fax> (408) 537-4042</fax>  
  </company>  
  <email>jsmith@adobe.com</email>  
</businesscard>
```

# XML for Business Cards

## An Element

## Nested Element

```
<businesscard>
  <name sex="M" suffix="Jr." >Joe Smith</name>
  <title>Principal Scientist</title>
  <company>
    <name>Adobe Systems Incorporated</name>
    <address>345 Park Avenue</address>
    <address>San Jose, Ca 95110-2704</address>
    <phone> (408) 536-6000</phone>
    <fax> (408) 537-4042</fax>
  </company>
  <email>jsmith@adobe.com</email>
</businesscard>
```

# XML for Business Cards

## Repeated Elements

```
<businesscard>
  <name sex="M" suffix="Jr." >Joe Smith</name>
  <title>Principal Scientist</title>
  <company>
    <name>Adobe Systems Incorporated</name>
    <address>345 Park Avenue</address>
    <address>San Jose, Ca 95110-2704</address>
    <phone> (408) 536-6000</phone>
    <fax> (408) 537-4042</fax>
  </company>
  <email>jsmith@adobe.com</email>
</businesscard>
```

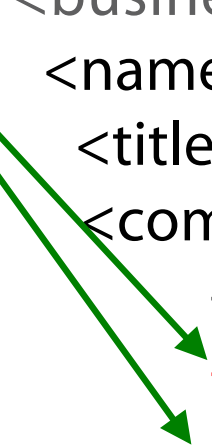

# XML for Business Cards

## Named Attributes

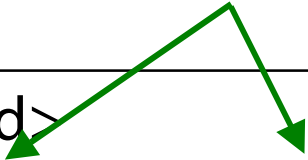

```
<businesscard>  
  <name sex="M" suffix="Jr." >Joe Smith</name>  
  <title>Principal Scientist</title>  
  <company>  
    <name>Adobe Systems Incorporated</name>  
    <address>345 Park Avenue</address>  
    <address>San Jose, Ca 95110-2704</address>  
    <phone> (408) 536-6000</phone>  
    <fax> (408) 537-4042</fax>  
  </company>  
  <email>jsmith@adobe.com</email>  
</businesscard>
```

# Graph of a <businesscard>

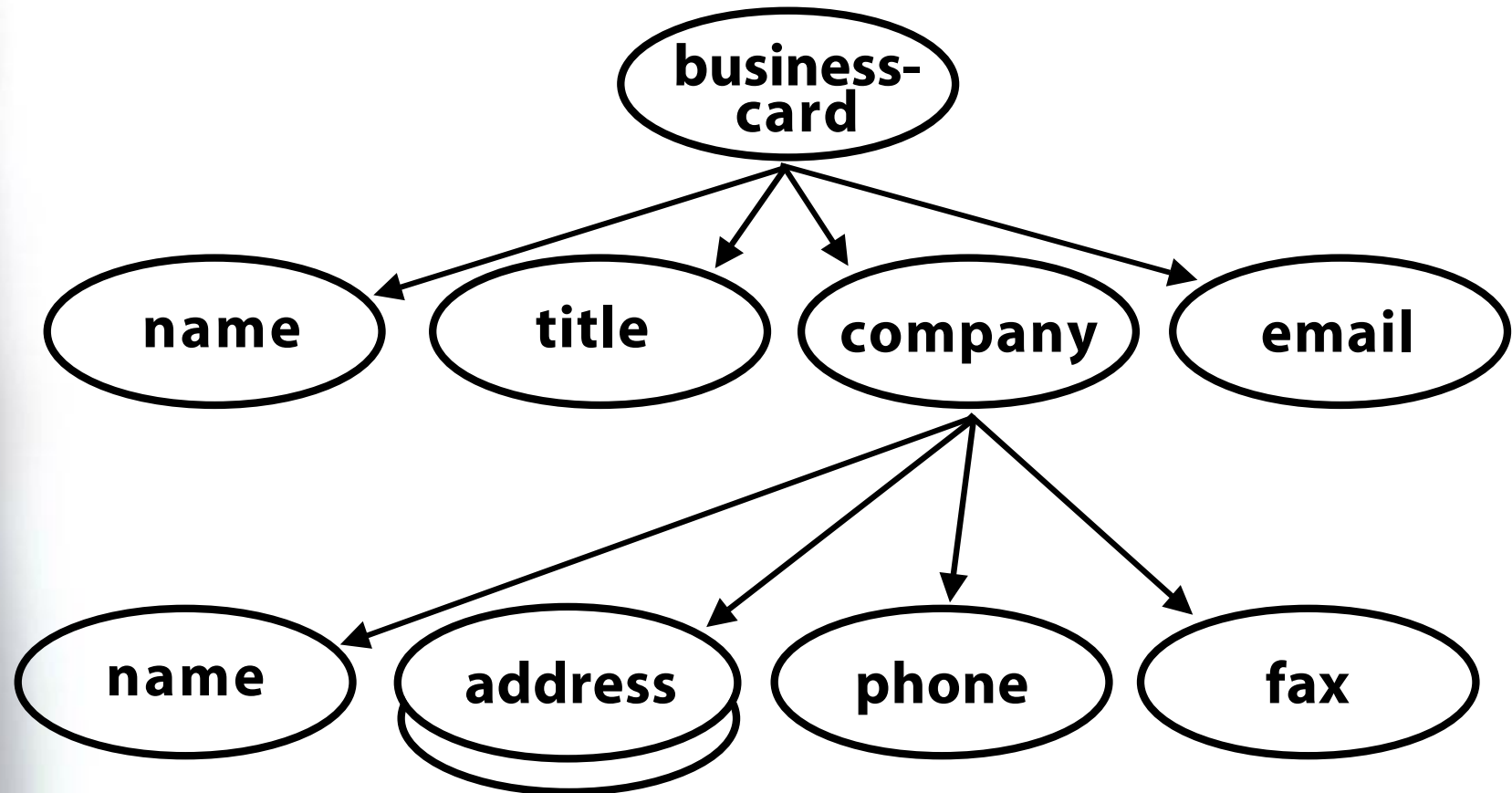

# Graph of a <businesscard>

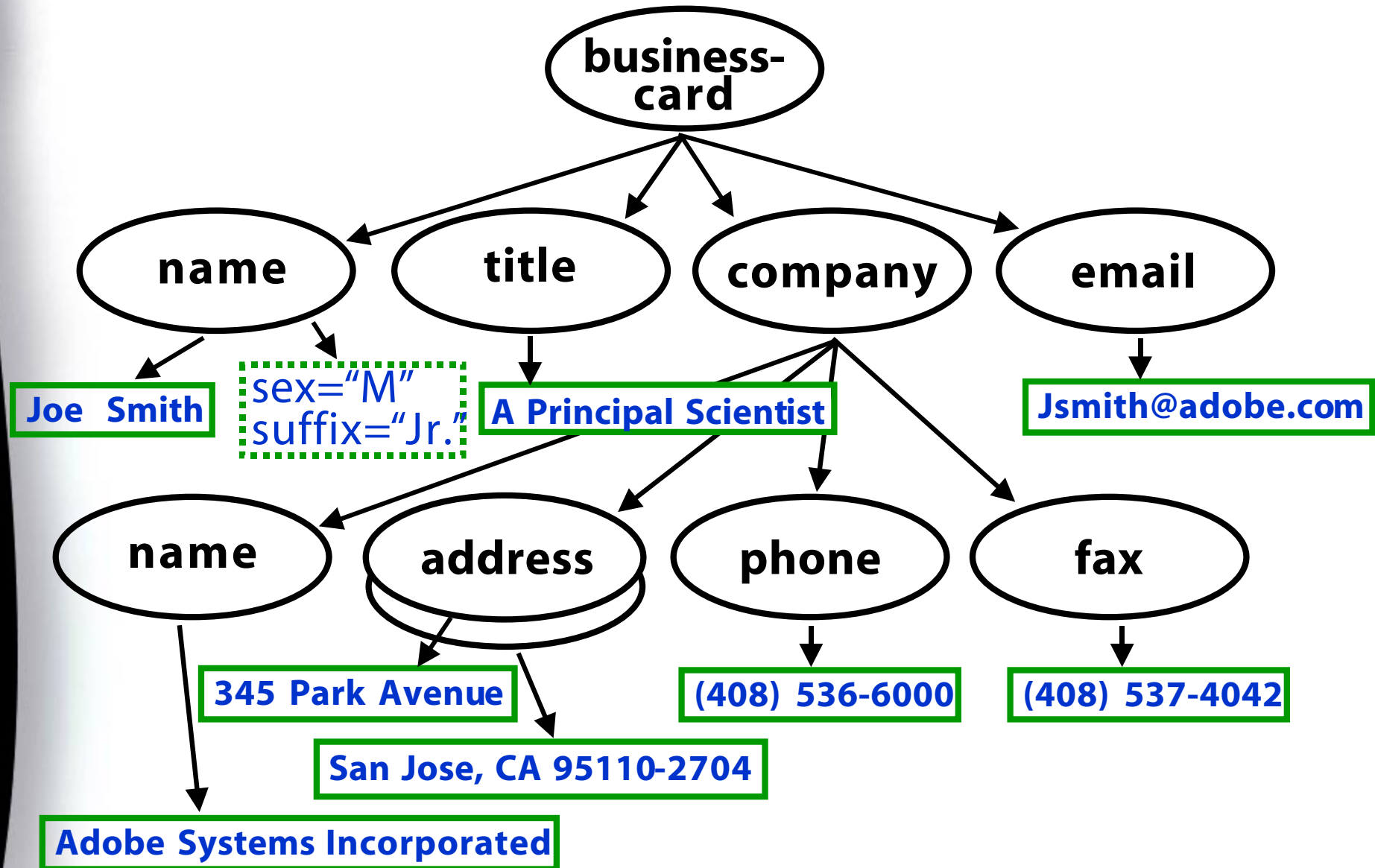

# Document Object Model (DOM)

- An API for manipulating graphs
  - For XML and HTML
  - Create, walk and edit the graph(`getNamedItem`, `appendChild`, `hasChildNodes?`, etc.)
  - Interfaces for web scripting languages

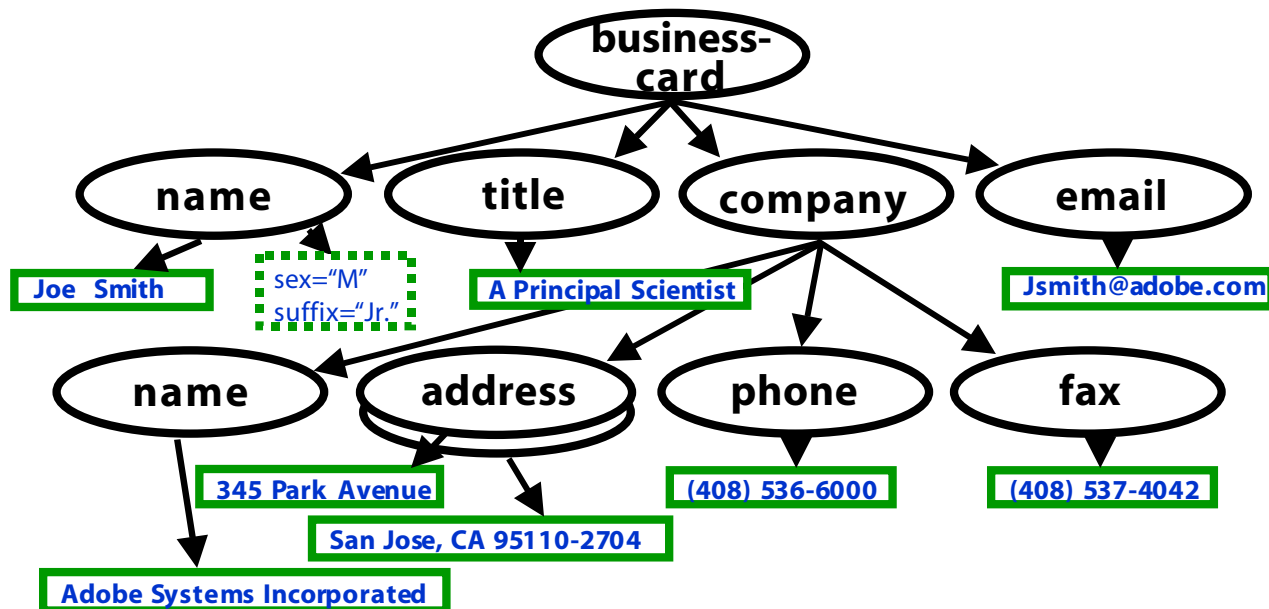

# XML Markup Languages

- **XML for Business Cards**
  - *XML basics: elements and attributes*
  - *DOM (Document Object Model)*
- **Standard XML Markup Languages**
- **XML for HTML**

# XML Markup Languages

- **Sample International Standards:**
  - *SVG* – *XML for Scalable Vector Graphics*
  - *OEB* – *XML for Open Electronic Books*
  - *JDF* – *XML for Job Definition Format (print)*
  - *XSL* – *XML for Extensible Stylesheet Language*
  - *NewsML*– *XML for News Stories*
  
- **Or, check the “XML Catalog” at:**  
<http://www.xml.org>

# XML Markup Languages

- **XML for Business Cards**
  - *XML basics: elements and attributes*
  - *DOM (Document Object Model)*
- **Standard XML Markup Languages**
- **XML for HTML**

# XML for HTML

- Called “XHTML”
- Brings HTML into the XML family
  - *Tightening some of the rules*
    - e.g., `<p> ... </p>` must come in pairs
    - e.g., quotes required on attribute values (`x="3"`)

• XHTML is one of many XML Markup Languages

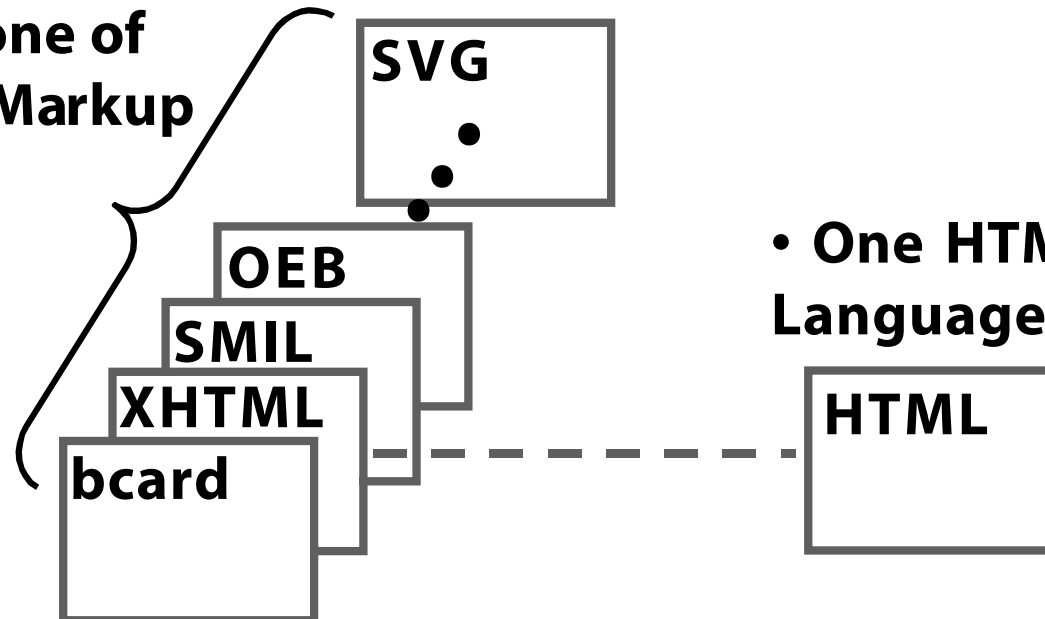

• One HTML Markup Language

# XML **for** ...

- Must qualify what the XML is **for**
  - XML **for** *Business Cards*
  - XML **for** *HTML (XHTML)*
  - XML **for** *Print Job Definition Format (JDF)*
  - XML **for** *Scalable Vector Graphics (SVG)*
  - ...
- OR
  - XML **for** *Structure*
  - XML **for** *Flowable Presentation (XHTML)*
  - XML **for** *Final Presentation (SVG)*

# Markup: Primary Uses

## ■ Structural Markup

- *Data Exchange*
- *Data Storage*
- *To feed presentation markup*

## ■ Presentation Markup

- *Flowable*
- *Final*

# Markup for Structure

## Example: Business Card

- **Identify elements (parts of data)**
  - *Give them names (<email>)*
  - *Provide their attributes (sex="M")*
- **Show hierarchical relationships**
  - *Nesting of elements*
- **Linking**
  - *Non hierarchical relationships*
- **Data exchange and storage**

# Markup: Primary Uses

## ■ Structural Markup

- *Data Exchange*
- *Data Storage*
- *To feed presentation*

**Done with this here!**

## ■ Presentation Markup

- *Flowable*
- *Final*

**Will discuss further!**

# Markup for Presentation

## Example: XHTML (Lincoln E-Mail)

- **Contains styling information**

- `<font size="5" color="red">B</font>`
- `<table><tr><td height="80" width="15%" valign="bottom"> ... </td></tr></table>`

- **Flowable Presentation Markup**

- `<p>Four score and seven years ago our fathers brought forth on this continent, a new nation, conceived in Liberty, and dedicated to the proposition that all men are created equal. </p>`

- **Final Presentation Markup**

- `<text y="185" x="12">Four score and seven years ago our fathers brought forth on this continent, a new nation, conceived in Liberty, </text>`  
`<text y="205" x="12">and dedicated to the proposition that all men are created equal. </text>`

# Processing the Markup

- **From Structural Markup to screen bitmaps**

# Processing Markup (for Presentation)

## ■ From Structural Markup to Bit Maps

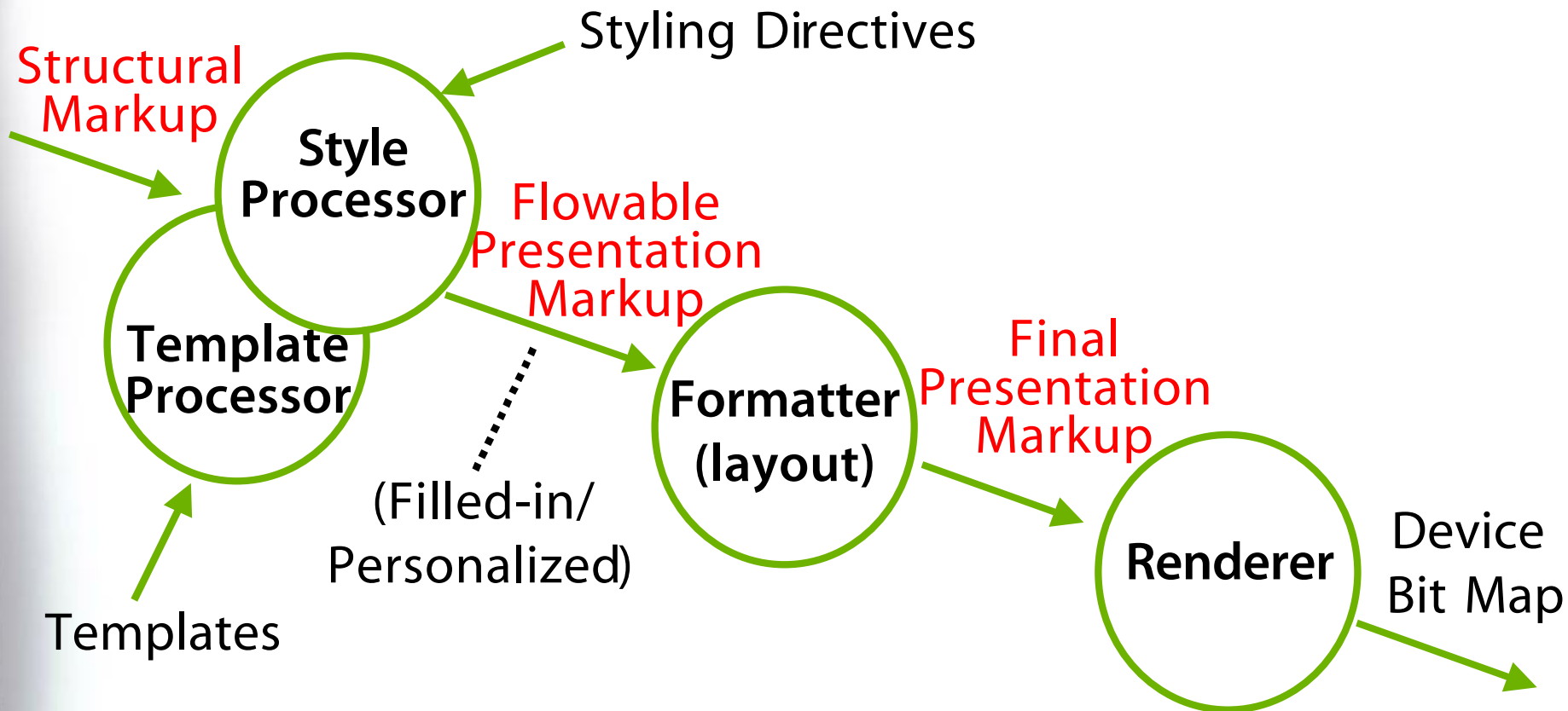

Let's Standardize our Terminology!

# Web Browsers

## ■ Formatter and Renderer merged

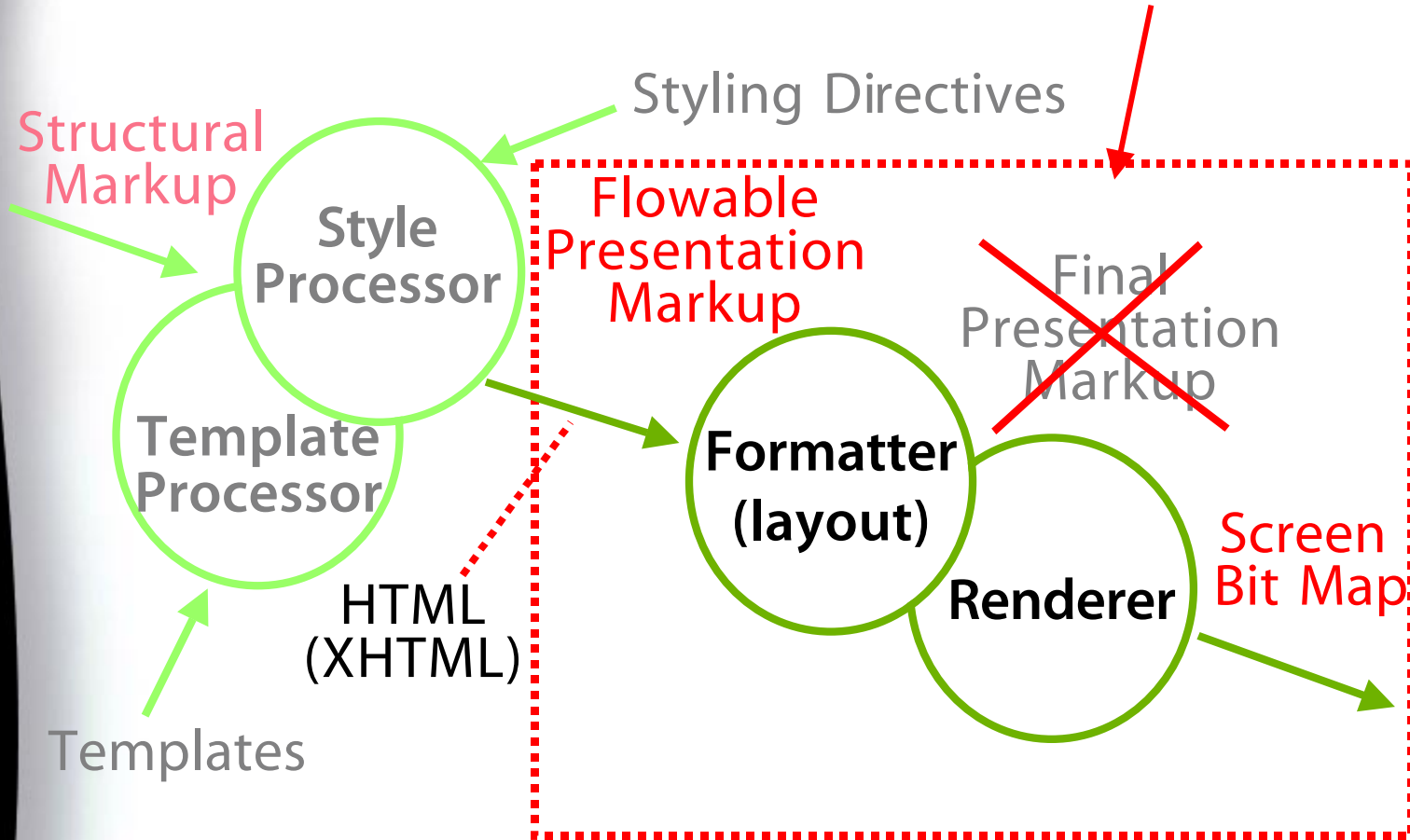

# Style and Template Processing

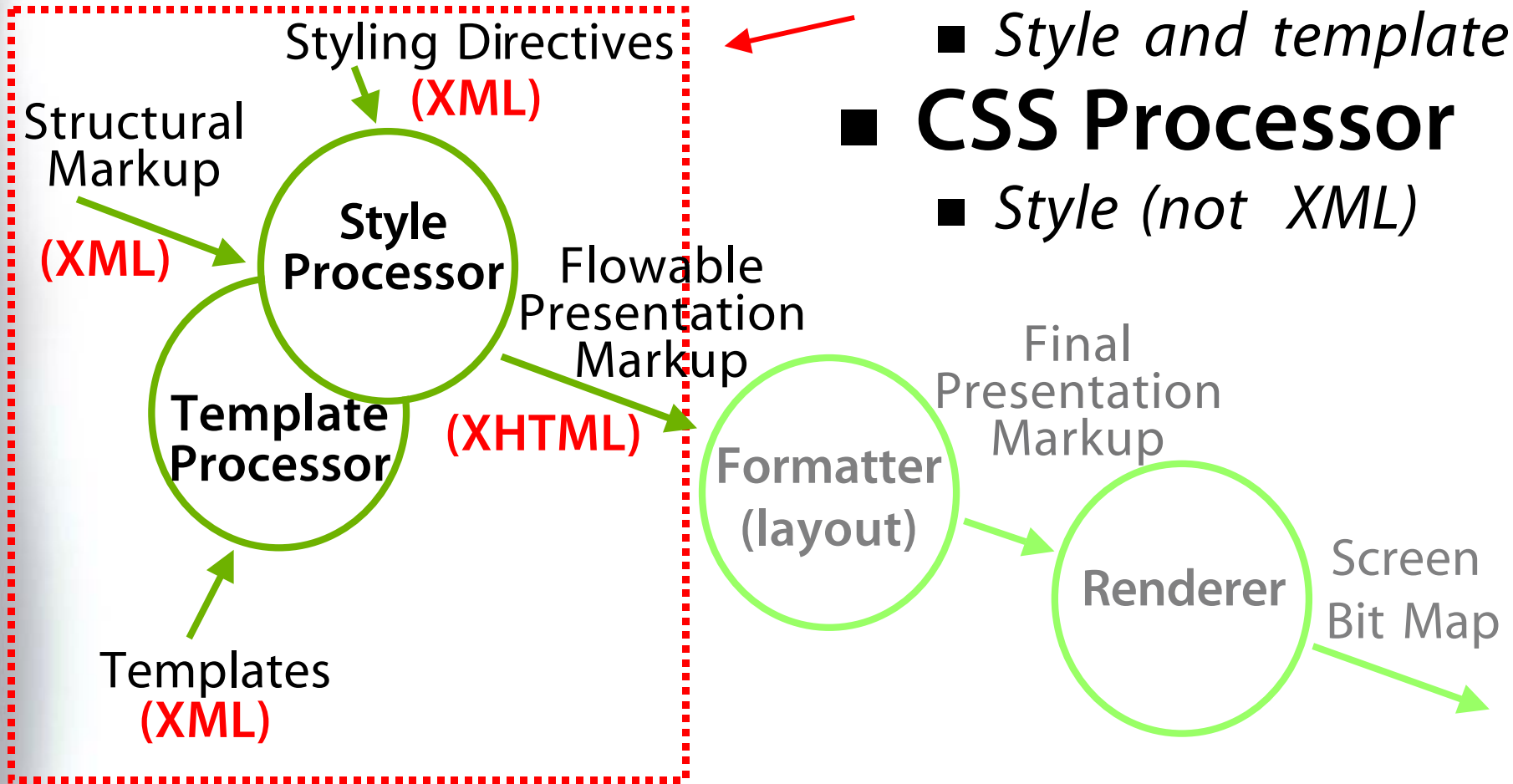

## ■ XSL Processor

- *Style and template*

## ■ CSS Processor

- *Style (not XML)*

# Style and Template Processing

## ■ Extensible (Generic) Formatting

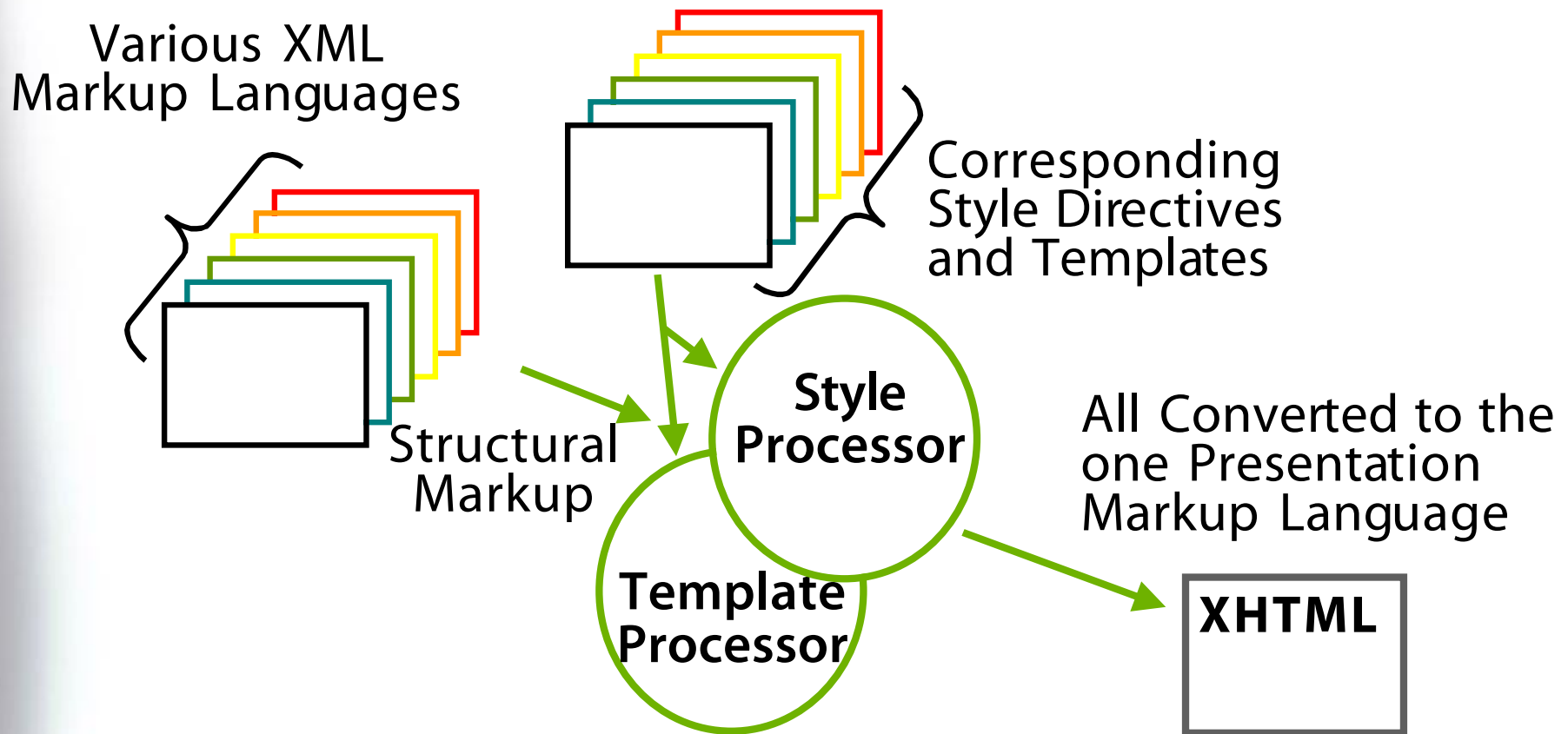

# XML Markup Languages

- Examples exist for all **red** items

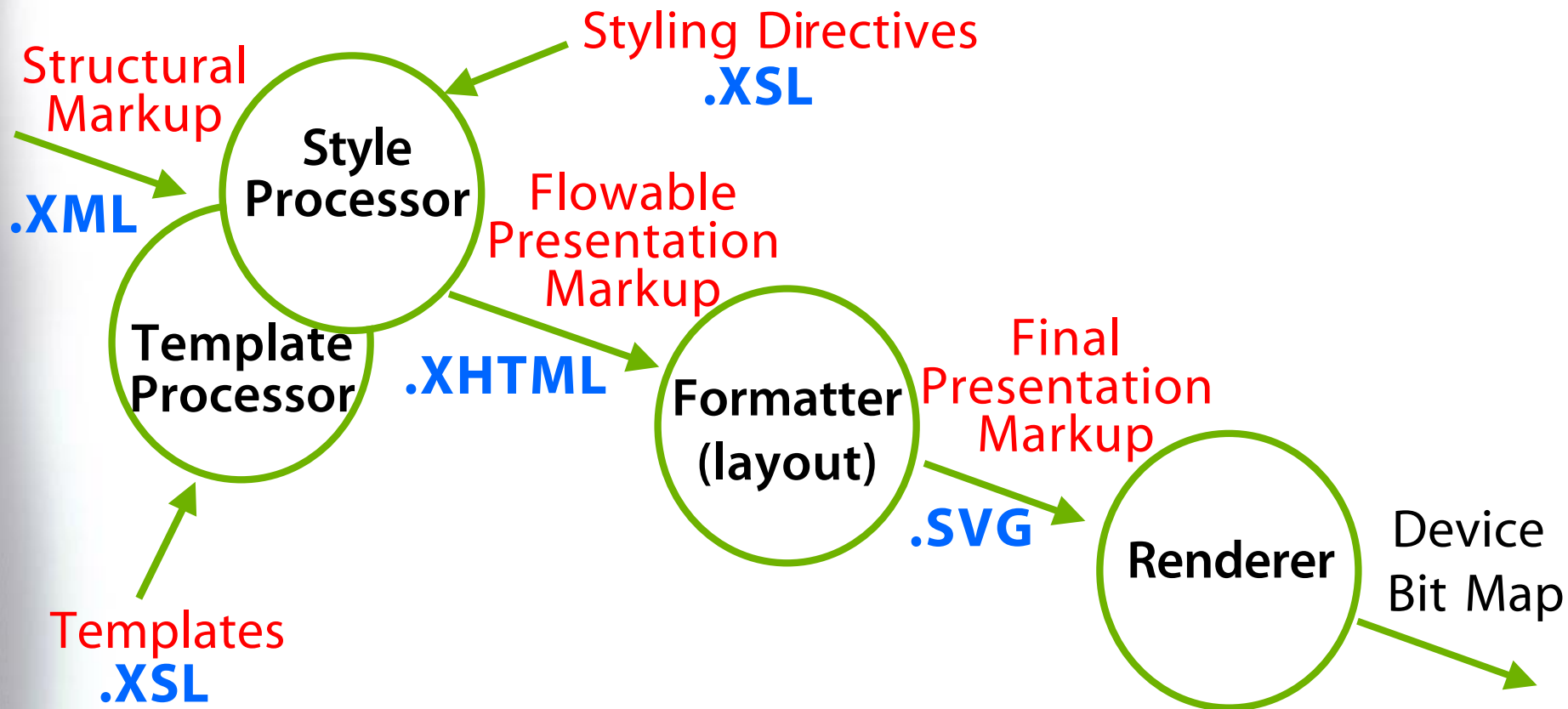

# The Many Faces of XML (Structure)

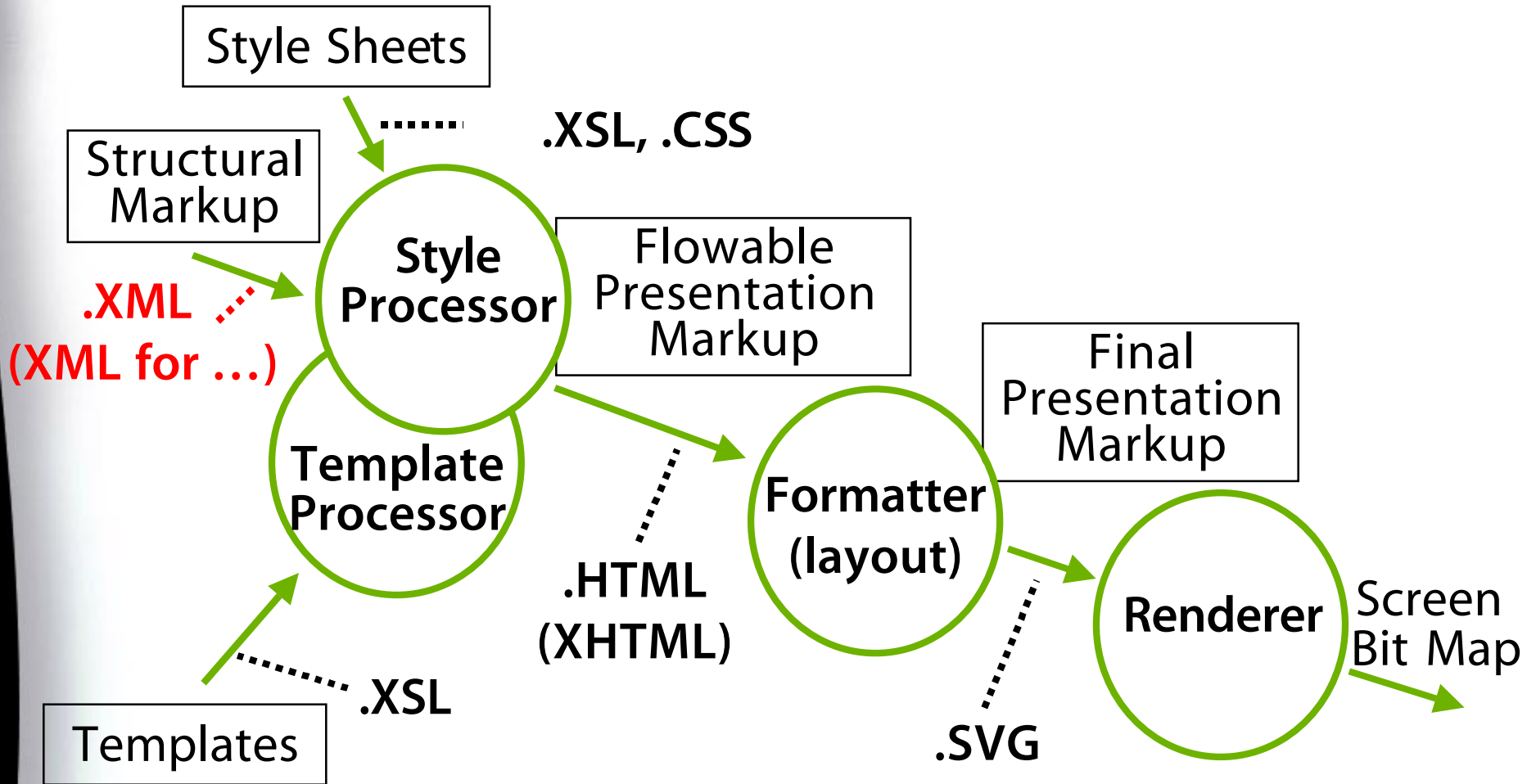

# Structural Markup (.xml)

```
<?xml version="1.0" ?>
```

```
<?xml-stylesheet type="text/xsl" href="GettysburgAddress2.xsl"?>
```

```
<memo>
```

**A <memo> not an <html> !**

```
<heading>
```

```
  <to>Edward Everett</to>
```

```
  <from>Abraham Lincoln</from>
```

```
  <subject>FYI--President's Official Dedication to be Delivered  
After Your Oration</subject>
```

```
  <dated>November 18, 1863</dated>
```

```
</heading>
```

**No presentation directives**

```
<body>
```

```
<p>
```

```
<bchar>F</bchar>our score and seven years ago our fathers brought  
forth on this continent, a new nation, conceived in Liberty, and  
dedicated to the proposition that all men are created equal.
```

```
</p>
```

# Structural Mark-Up (.xml)

`<p><bchar>N</bchar>`ow we are engaged in a great civil war, testing whether that nation, or any nation so conceived and so dedicated, can long endure. We are met on a great battle-field of that war. We have come to dedicate a portion of that field, as a final resting place for those who here gave their lives that that nation might live. It is altogether fitting and proper that we should do this.

`</p>`

`<p> <bchar>B</bchar>`ut, in a larger sense, we can not dedicate--we can not consecrate--we can not hallow--this ground. The brave men, living and dead, who struggled here, have consecrated it, far above our poor power to add or detract. The world will little note, nor long remember what we say here, but it can never forget what they did here. It is for us the living, rather, to be dedicated here to

# Structural Mark-Up (.xml)

the unfinished work which they who fought here have thus far so nobly advanced. It is rather for us to be here dedicated to the great task remaining before us--that from these honored dead we take increased devotion to that cause for which they gave the last full measure of devotion--that we here highly resolve that these dead shall not have died in vain--that this nation, under God, shall have a new birth of freedom--and that government of the people, by the people, for the people shall not perish from the earth.

</p>

<p>

November 19, 1863. Abraham Lincoln.

</p>

</body>

</memo>

# The Many Faces of XML (Flowable Presentation)

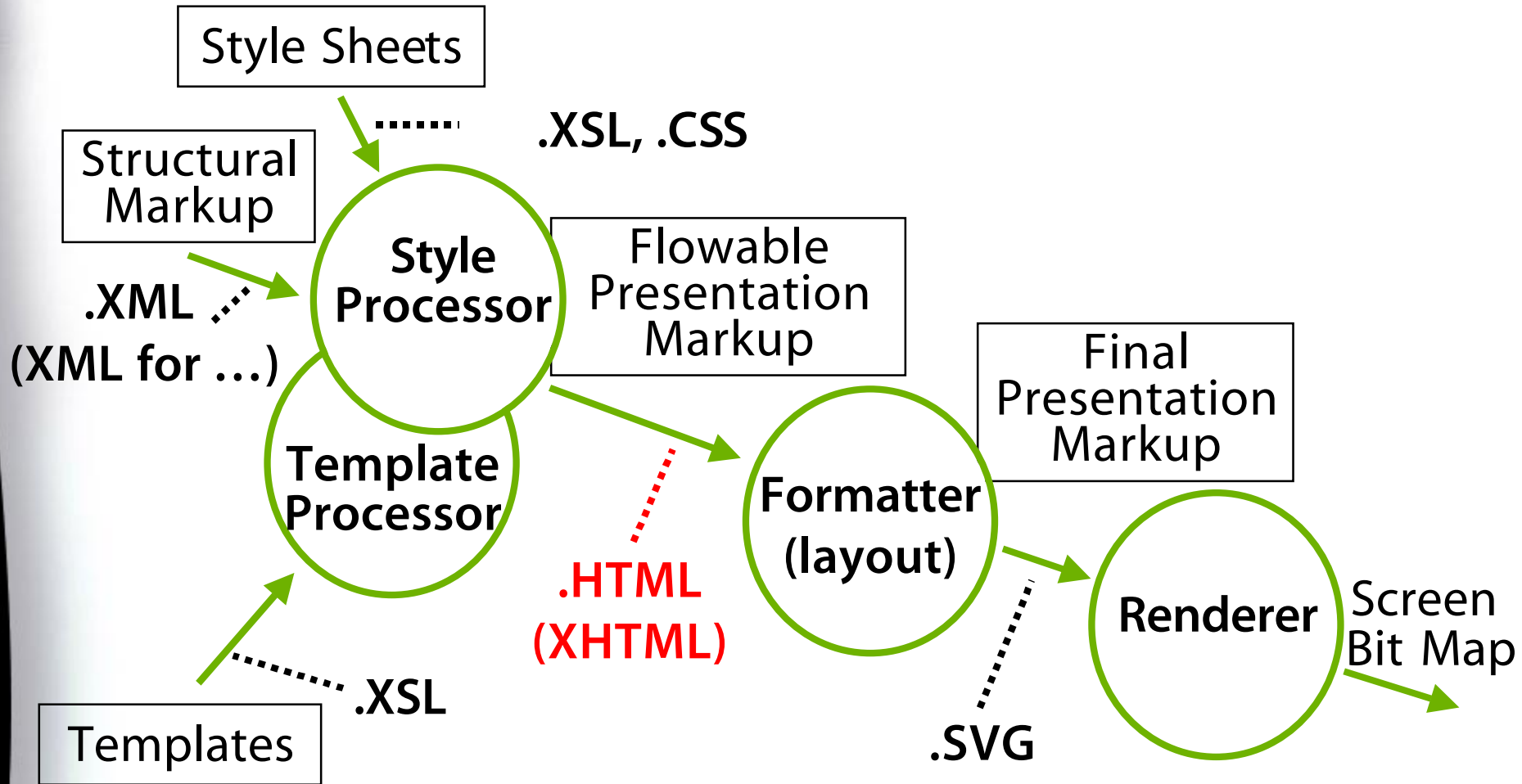

# Flowable Presentation Mark-Up

```
<!DOCTYPE html PUBLIC "-//W3C//DTD XHTML 1.0 Strict//EN" "DTD/xhtml1-strict.dtd">
```

```
<html>
```

Now it is an `<html>` !

```
<body bgcolor="#FFFFFF">
```

```

```

```
<font size="2">
```

Lots of presentation directives

```
<table>
```

```
<tr>
```

```
<td height="80" width="15%" valign="bottom"><font style="font-style:italic; color:#0055ff">To:</font></td>
```

```
<td valign="bottom" ><font style="font-family:'Techno'; color:#808080">Edward Everett</font></td>
```

```
</tr><tr>
```

```
<td><font style="font-style:italic; color:#0055ff">From:</font></td>
```

```
<td><font style="font-family:'Techno'; color:#808080">Abraham  
Lincoln</td>
```

```
</tr>
```

# Flowable Presentation Mark-Up

```
<tr><td valign="top"><font style="font-family:'Techno'; color:#0055ff">Subject:</font>
```

**Text generated during styling**

```
<td><font style="font-family:'Techno'; color:#808080">FYI--  
President's Official Dedication to be Delivered After Your  
Oration</td>
```

```
</tr><tr>
```

```
<td><font style="font-style:italic; color:#0055ff">Date:</font></td>  
<td><font style="font-family:'Techno'; color:#808080">November  
18, 1863</td>
```

```
</tr></table></font>
```

```
<hr></hr>
```

```
<p><font style="font-size:large; color:red"> F</font>our score and  
seven years ago our fathers brought forth on this continent, a new  
nation, conceived in Liberty, and dedicated to the proposition that all  
men are created equal.
```

```
</p>
```

# Flowable Presentation Mark-Up

`<p><font style="font-size:large; color:red">N</font>`ow we are engaged in a great civil war, testing whether that nation, or any nation so conceived and so dedicated, can long endure. We are met on a great battle-field of that war. We have come to dedicate a portion of that field, as a final resting place for those who here gave their lives that that nation might live. It is altogether fitting and proper that we should do this.

`</p>`

`<p><font style="font-size:large; color:red">B</font>`ut, in a larger sense, we can not dedicate--we can not consecrate--we can not hallow--this ground. The brave men, living and dead, who struggled here, have consecrated it, far above our poor power to add or detract. The world will little note, nor long remember what we say here, but it can never forget what they did here. It is for us the living, rather,

# Flowable Presentation Mark-Up

to be dedicated here to the unfinished work which they who fought here have thus far so nobly advanced. It is rather for us to be here dedicated to the great task remaining before us--that from these honored dead we take increased devotion to that cause for which they gave the last full measure of devotion--that we here highly resolve that these dead shall not have died in vain--that this nation, under God, shall have a new birth of freedom--and that government of the people, by the people, for the people, shall not perish from the earth.

</p>

<p>  
    <font style="font-style:italic">November 19, 1863. Abraham Lincoln.  
    </font>

</p>

</body>

</html>

# The Many Faces of XML (Final Presentation)

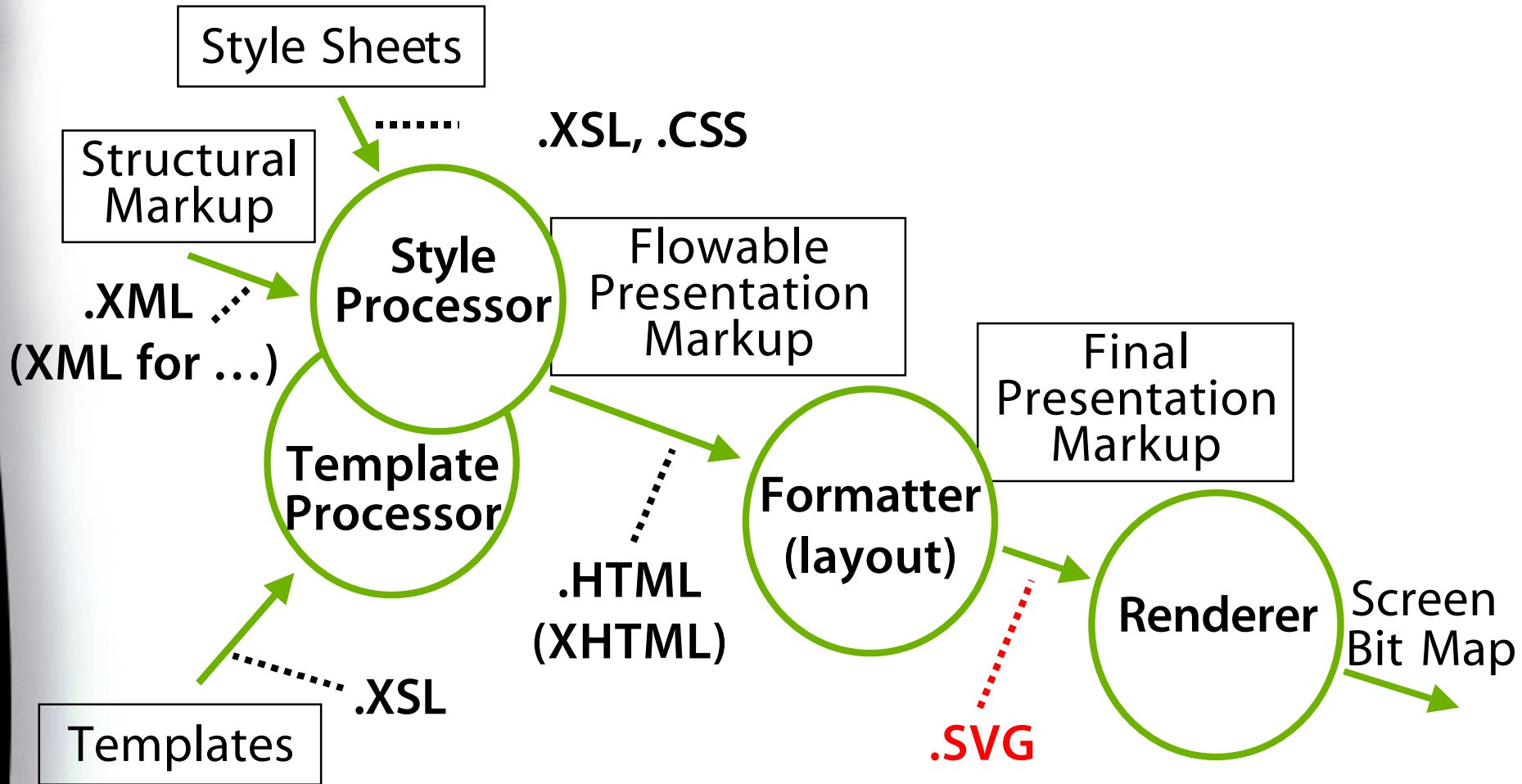

# Final Presentation Mark-Up (.svg)

```
<?xml version="1.0" encoding="utf-8"?>
<svg width="612" height="792" xml:space="preserve" xmlns:xlink=
      "http://www.w3.org/2000/xlink/namespace">
  <image width="1" height="1" xlink:href="US_Seal.gif"
          transform="matrix(80 0 0 80 500 10)"/>
  <g transform="matrix(1 0 0 1 26 0)" style="fill:#0055FF;
      font-family:'AdobeCorpID-MyriadLtIt'; font-size:14;">
    <text y="100">To:</text>
    <text y="115">From:</text>
    <text y="130">Subject:</text>
    <text y="145">Date:</text>
  </g>
  <g transform="matrix(1 0 0 1 75 0)" style="fill:#000000;
      font-family:'AdobeCorpID-MyriadRg'; font-size:14;">
    <text y="100">Edward Everett</text>
    <text y="115">Abraham Lincoln</text>
    <text y="130">FYI--President's Official Dedication to be
Delivered After Your Oration</text>
    <text y="145">November 18, 1863</text>
  </g>
```

**Absolute page positions**

# Final Presentation Mark-Up (.svg)

```
<path d="M10,160h600" style="stroke:#5555FF"/>  
  <g transform="matrix(1 0 0 1 10 0)" style="fill:#000000;  
    font-family:'AdobeCorpID-MinionRg'; font-size:13;">  
    <text y="185" style="font-size:24; fill:#FF0000">F</text>  
    <text y="185" x="12">our score and seven years ago our fathers  
brought forth on this continent, a new nation, conceived in  
Liberty,</text>  
    <text y="205">and dedicated to the proposition that all men are  
created equal.</text>  
    <text y="245" style="font-size:24; fill:#FF0000">N</text>  
    <text y="245" x="16">ow we are engaged in a great civil war,  
testing whether that nation, or any nation so conceived and so</text>  
    <text y="265">dedicated, can long endure. We are met on a great  
battle-field of that war. We have come to dedicate a portion</text>  
    <text y="285">of that field, as a final resting place for those who  
here gave their lives that that nation might live. It is altogether</text>  
    <text y="305">fitting and proper that we should do this.</text>
```

# Final Presentation Mark-Up (.svg)

<text y="345" style="font-size:24; fill:#FF0000">B</text>

<text y="345" x="16">ut, in a larger sense, we can not dedicate--  
we can not consecrate--we can not hallow--this ground. The  
brave</text>

<text y="365">men, living and dead, who struggled here, have  
consecrated it, far above our poor power to add or detract. The</text>

<text y="385">world will little note, nor long remember what we  
say here, but it can never forget what they did here. It is for us</text>

<text y="405">the living, rather, to be dedicated here to the  
unfinished work which they who fought here have thus far so  
nobly</text>

<text y="425">advanced. It is rather for us to be here dedicated  
to the great task remaining before us--that from these</text>

<text y="445">dead we take increased devotion to that cause for  
which they gave the last full measure of devotion--that we</text>

# Final Presentation Mark-Up (.svg)

`<text y="465">`here highly resolve that these dead shall not have died in vain--that this nation, under God, shall have a new birth`</text>`

`<text y="485">`of freedom--and that government of the people, by the people, for the people shall not perish from the earth.`</text>`

`<text y="525" style="font-family='Time-Italic';">`November 19, 1863. Abraham Lincoln.`</text>`

`</g>`

`</svg>`

# The Many Faces of XML

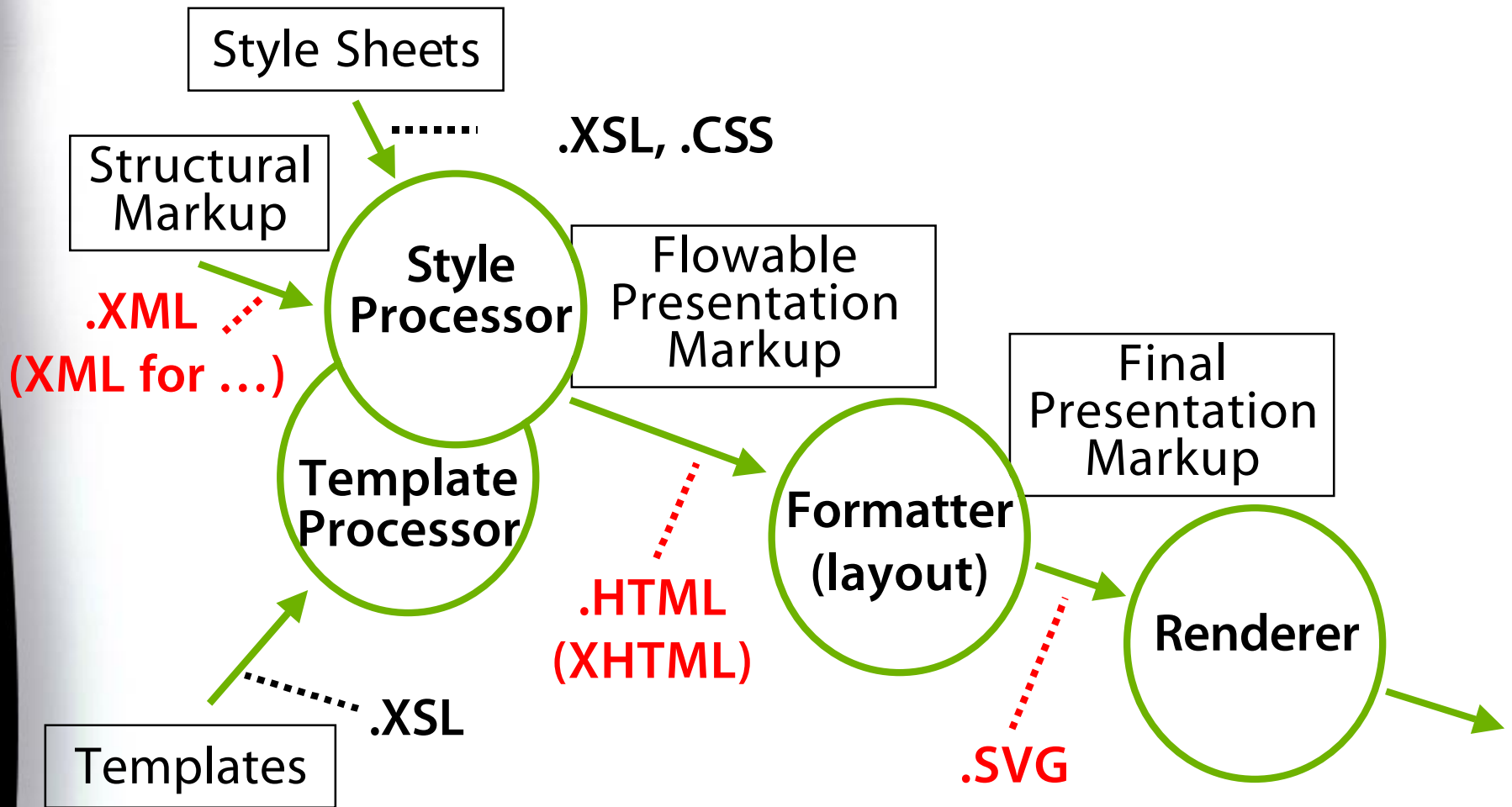

# PDF

- **A little about PDF**

# PDF

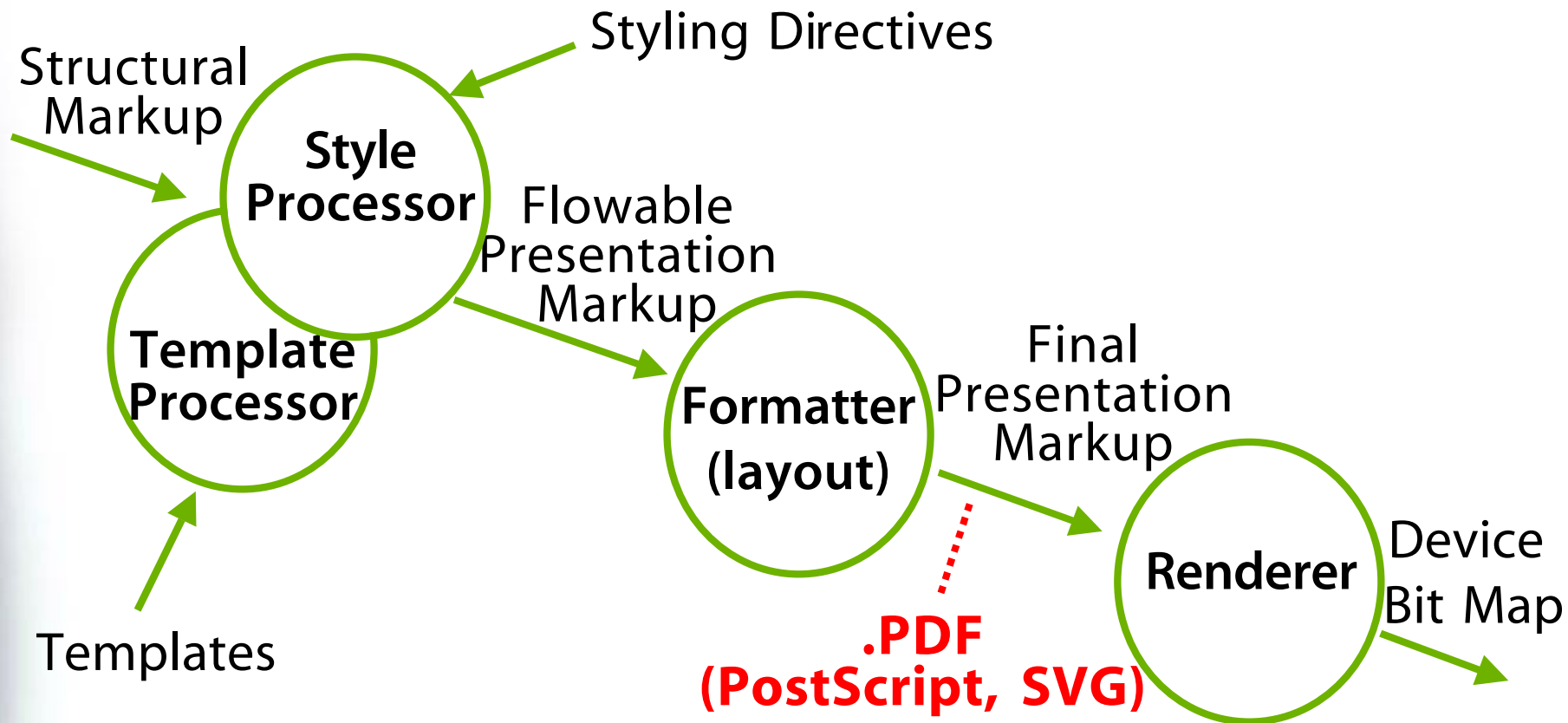

# PDF

- **Digital capture of print/screen output**
  - *Multi-page documents*
- **For each object precisely records**
  - *Exact position, color, font, etc.*
  - *Very precise and complete*
- **Device independent**
- **Replay to print, screen, film, etc.**
- **Batch or interactively formatted**
  - *human formatting to exact standards*

# But ...

- **I want one file to view**
  - *on my laptop*
  - *on my PDA*
  - *on my E-book reader*
  - *on my cellphone*
- **Must reflow text (at least)**

# With XML

## ■ Redo processing (styling by rules)

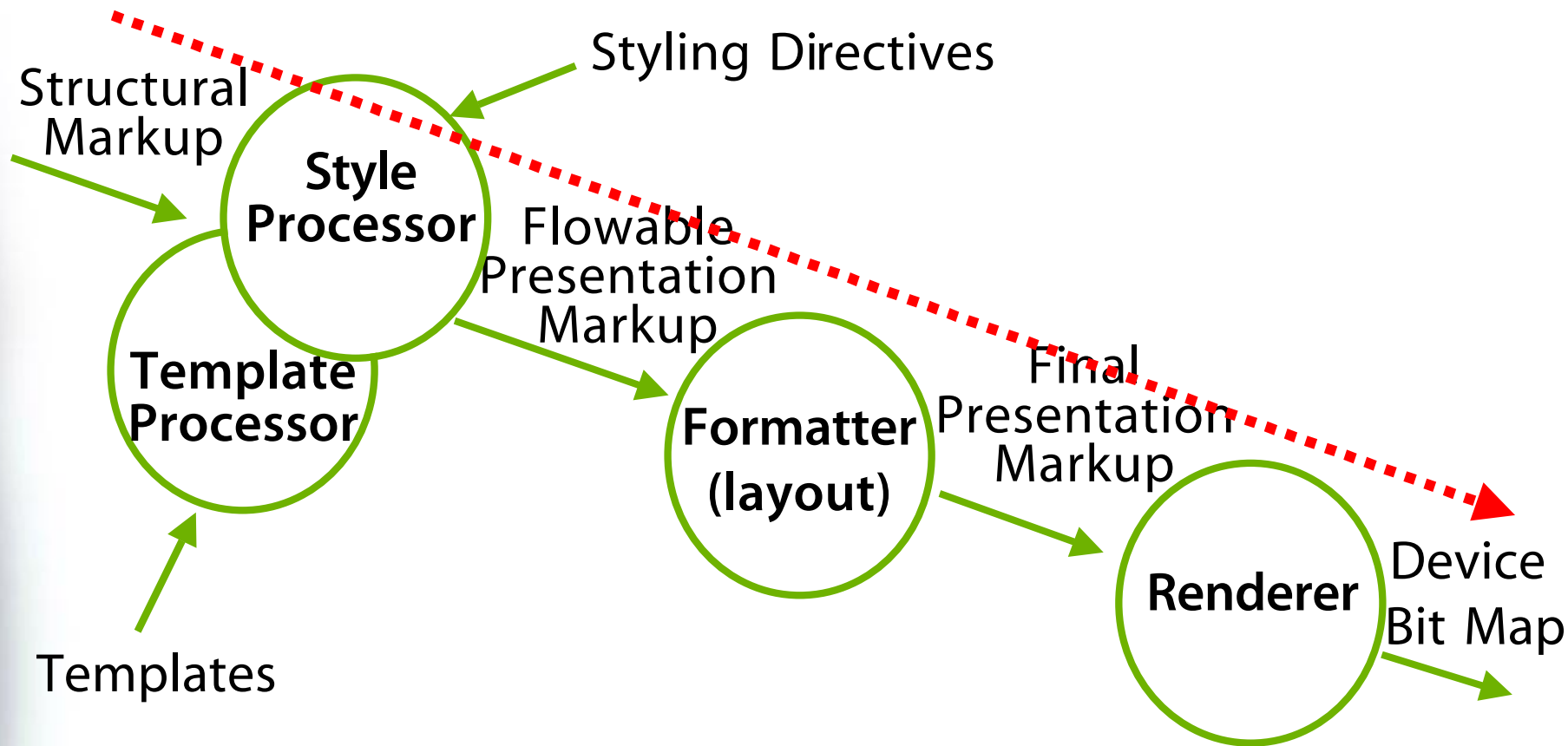

# Saving Structure in PDF

- Structural information normally lost
- Add ability to save some of it

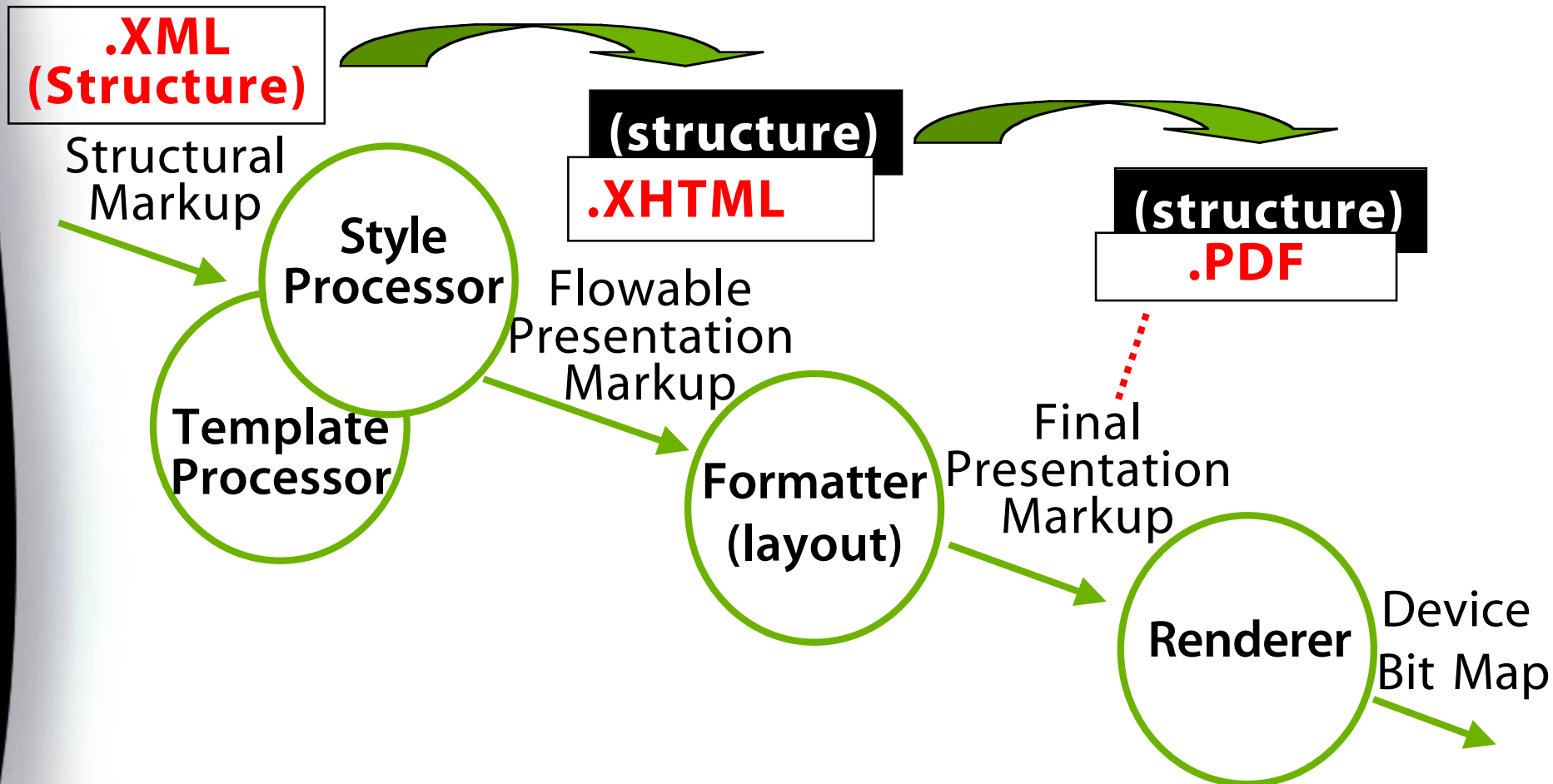

# Reflow of PDF

## ■ Partially reprocess

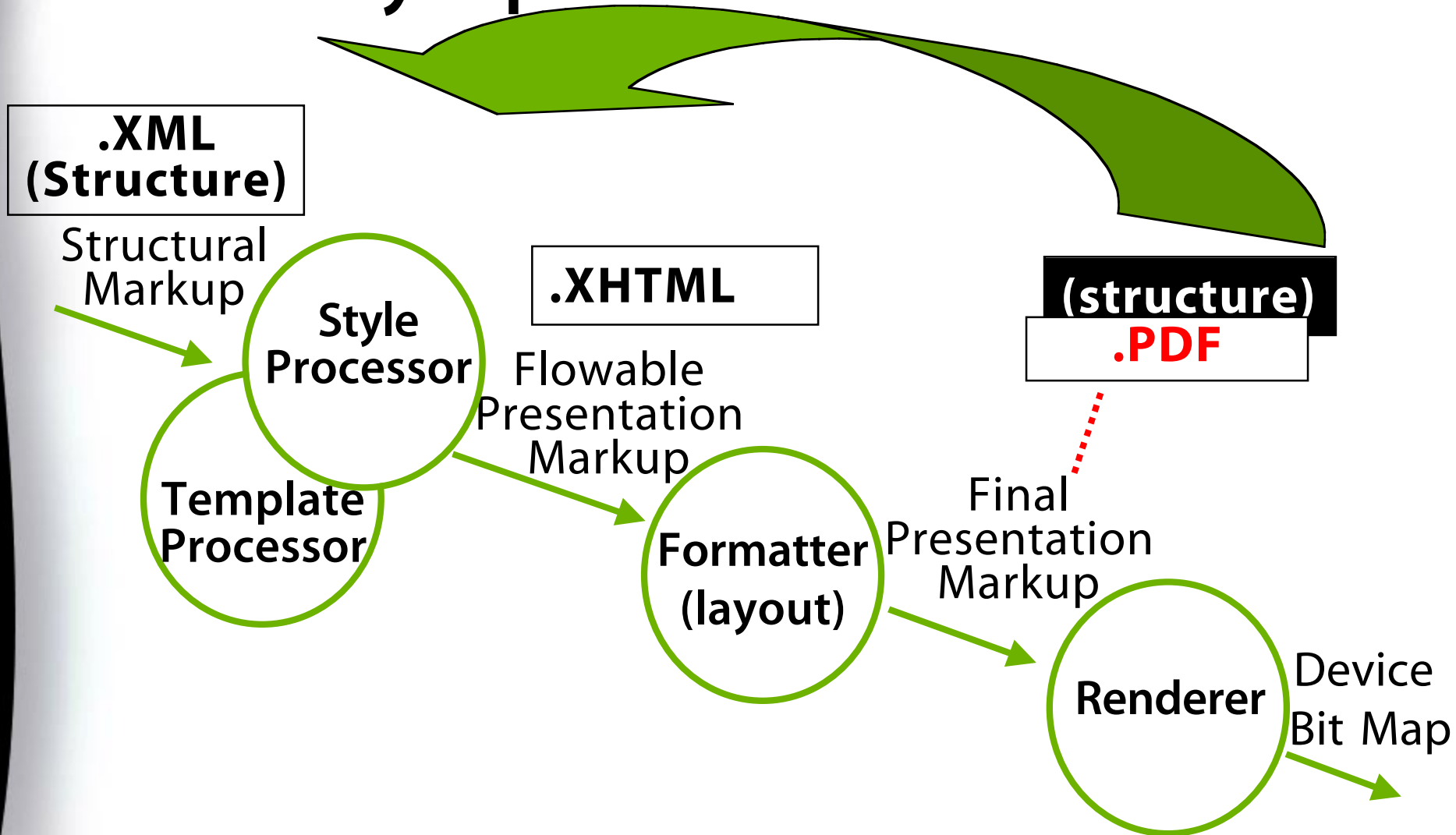

# Summary (XML)

- **XML is not a Markup Language**
  - *But is “rules and tools” for markup languages*
- **XML for ...**
  - *Business cards, html documents, style sheets, ...*
- **XML Markup Languages play many roles**
  - *Structural markup, flowable presentation, final presentation, or just structured data*
- **XML is powerful and happening!**

# Summary (PDF)

- **PDF starts as a presentation format**
  - *Precisely captures what would have printed*
- **People want more from PDF**
  - *Reflowable pages*
  - *Ability to construct “upstream” XML formats*
- **PDF is powerful and happening!**



Adobe

Inspiration becomes reality.™

[www.adobe.com](http://www.adobe.com)

```
document.write('<HTML HEAD profile="http-equiv="content-type" content="text/html; charset=utf-8" />');  
document.write('<META name="generator" content="Adobe Systems Incorporated" />');  
document.write('<META http-equiv="language" content="JavaScript" />');  
<!--  
currentSection = "sitemenu";  
lastOver;  
var preloadflag = false;  
worldwidePopped = false;  
var worldwideTimer;  
  
if (navigator.platform && (navigator.  
//mac users  
document.write('<LINK href="/ssi
```