

### 4004 PROCESSOR INTERFACE



Title: TTI_4004_FPGA	
Comments: TOP_LEVEL	
Date: 2 OF 6	Ver:
Sheet Size: C	Rev:



### KEYBOARD INTERFACE



Title: TTI_4004_FPGA	
Comments: TOP_LEVEL	
Date: 3 OF 6	Ver:
Sheet Size: C	Rev:

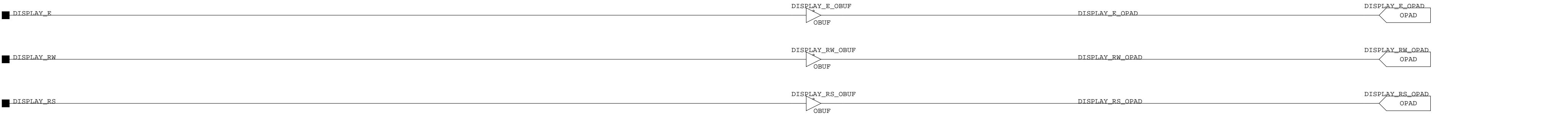
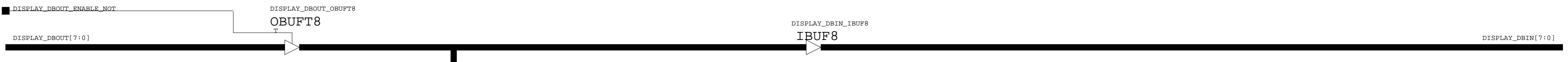
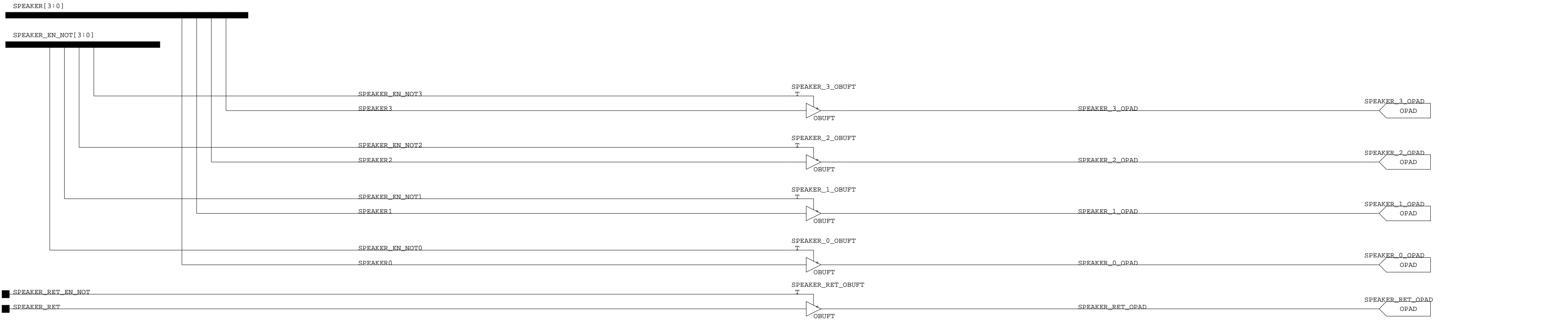

SOUND/SPEAKER INTERFACE  
& DISPLAY INTERFACE



Title: TTI_4004_FPGA	
Comments: TOP_LEVEL	
Date: 4 OF 6	Ver:
Sheet Size: C	Rev:

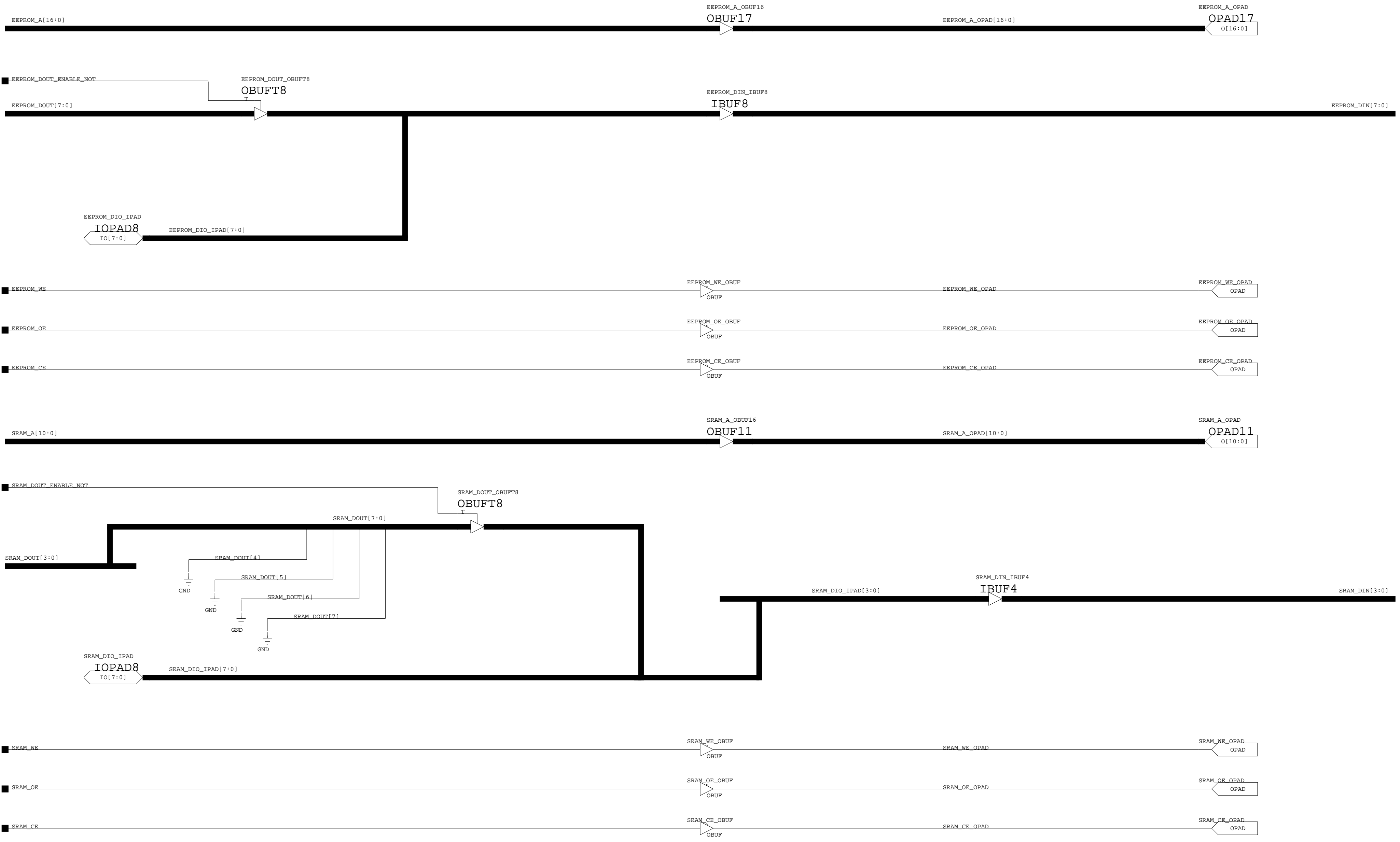

### EEPROM & SRAM INTERFACE



Title: TTI_4004_FPGA	
Comments: TOP_LEVEL	
Date: 5 OF 6	Ver:
Sheet Size: C	Rev:

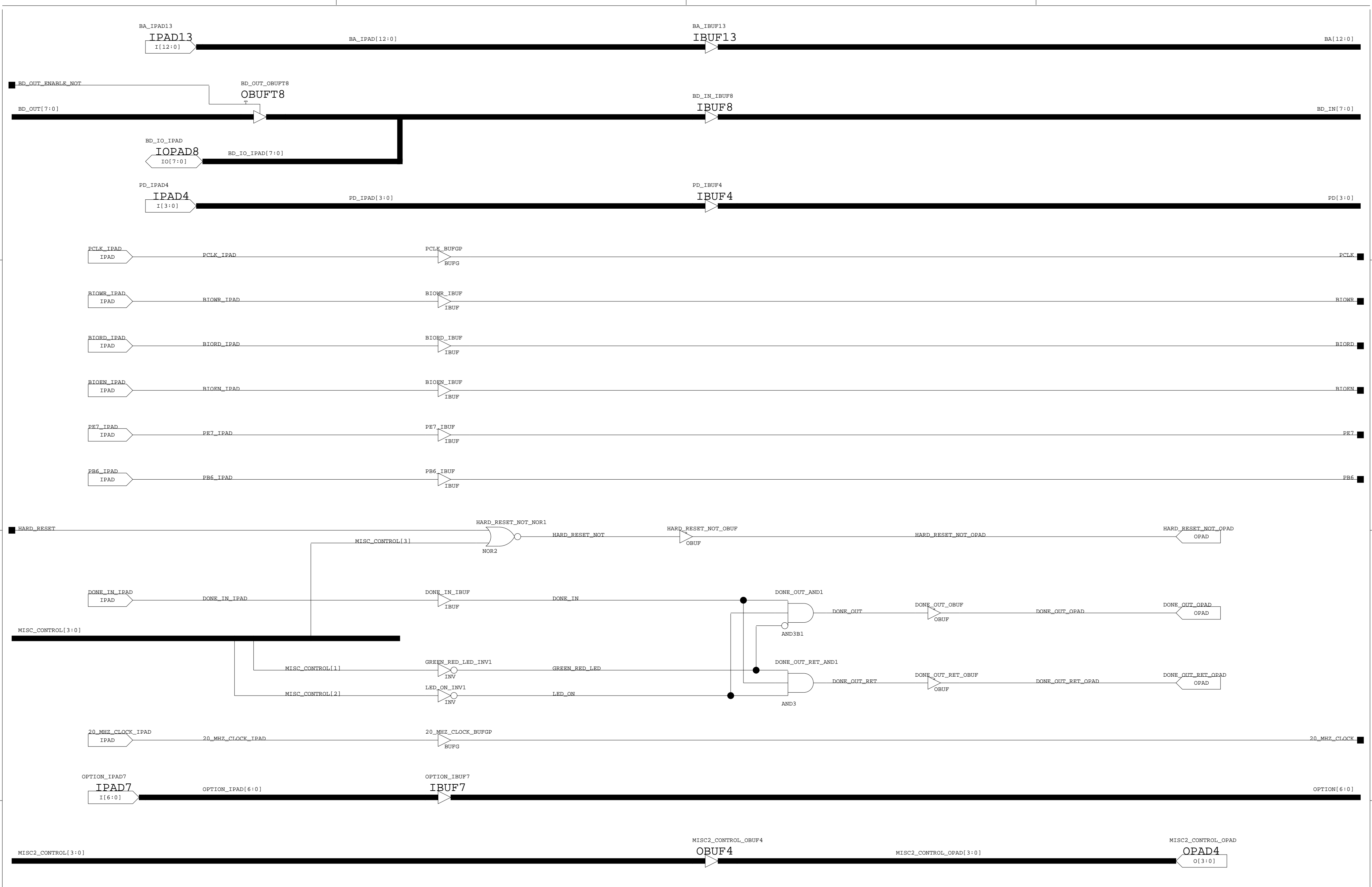

OPTION SWITCH, SYSTEM CLOCK,  
 DONE LED, HARD RESET INTERFACE,  
 MISC2 OUTPUT, & RABBIT INTERFACE



Title: TTI_4004_FPGA	
Comments: TOP_LEVEL	
Date: 6 OF 6	Ver:
Sheet Size: C	Rev:

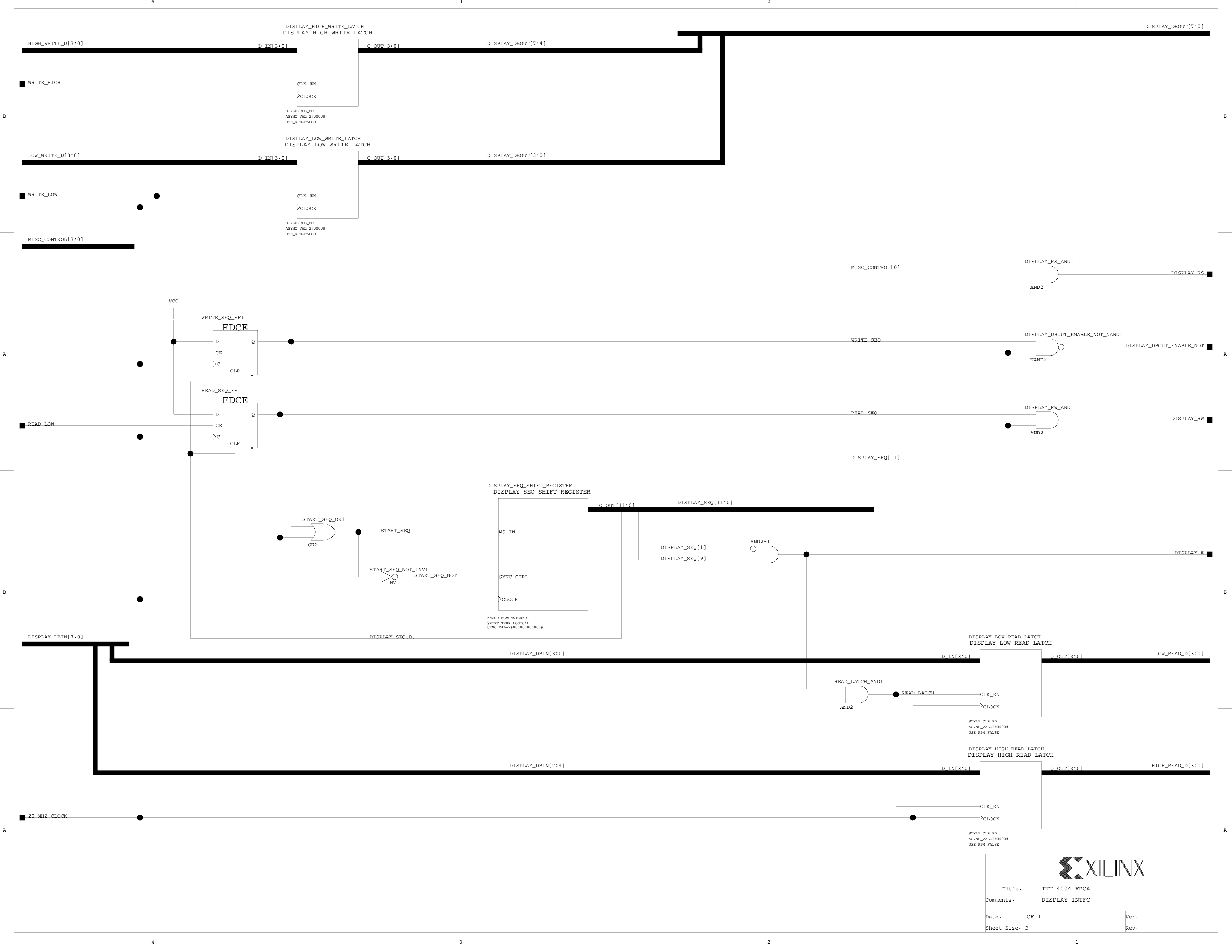

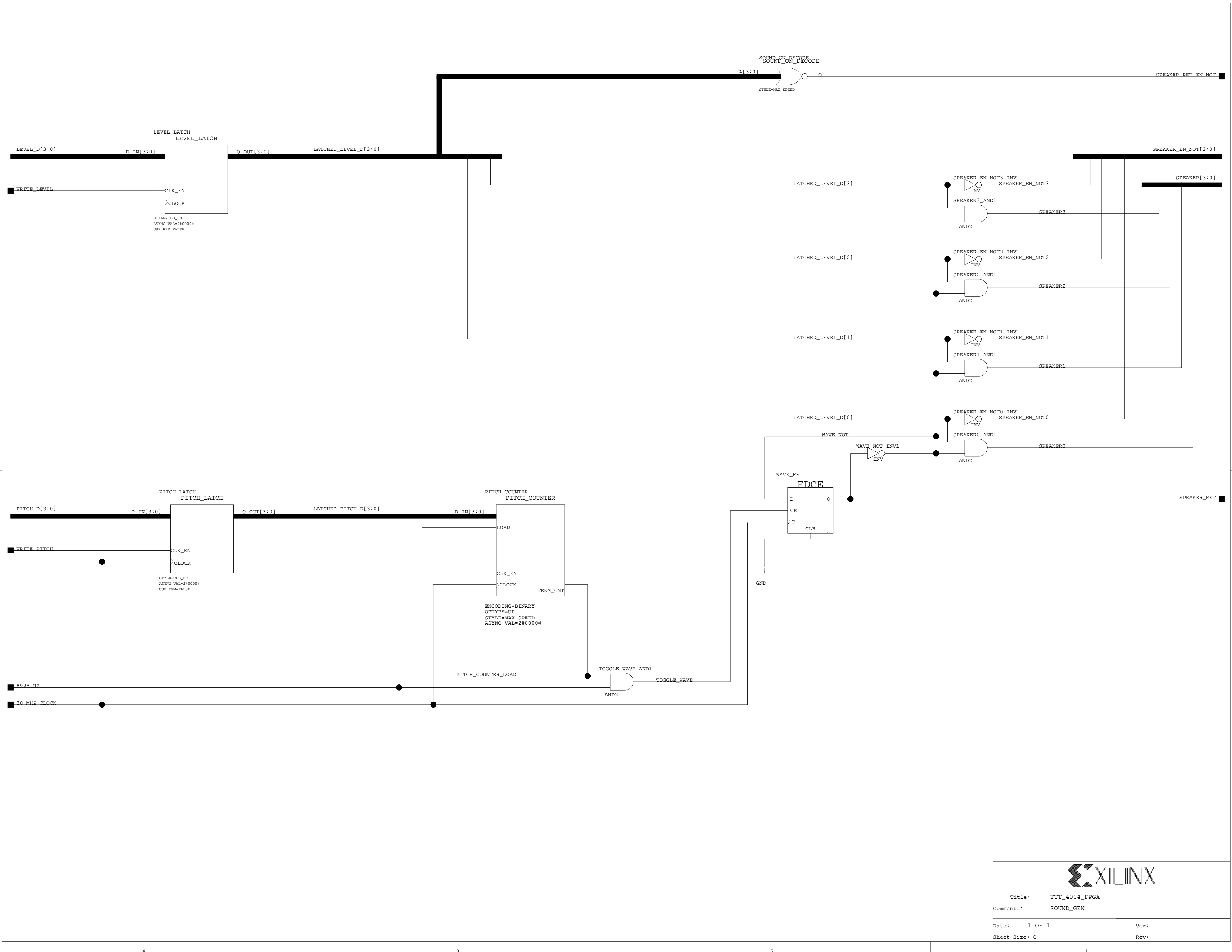

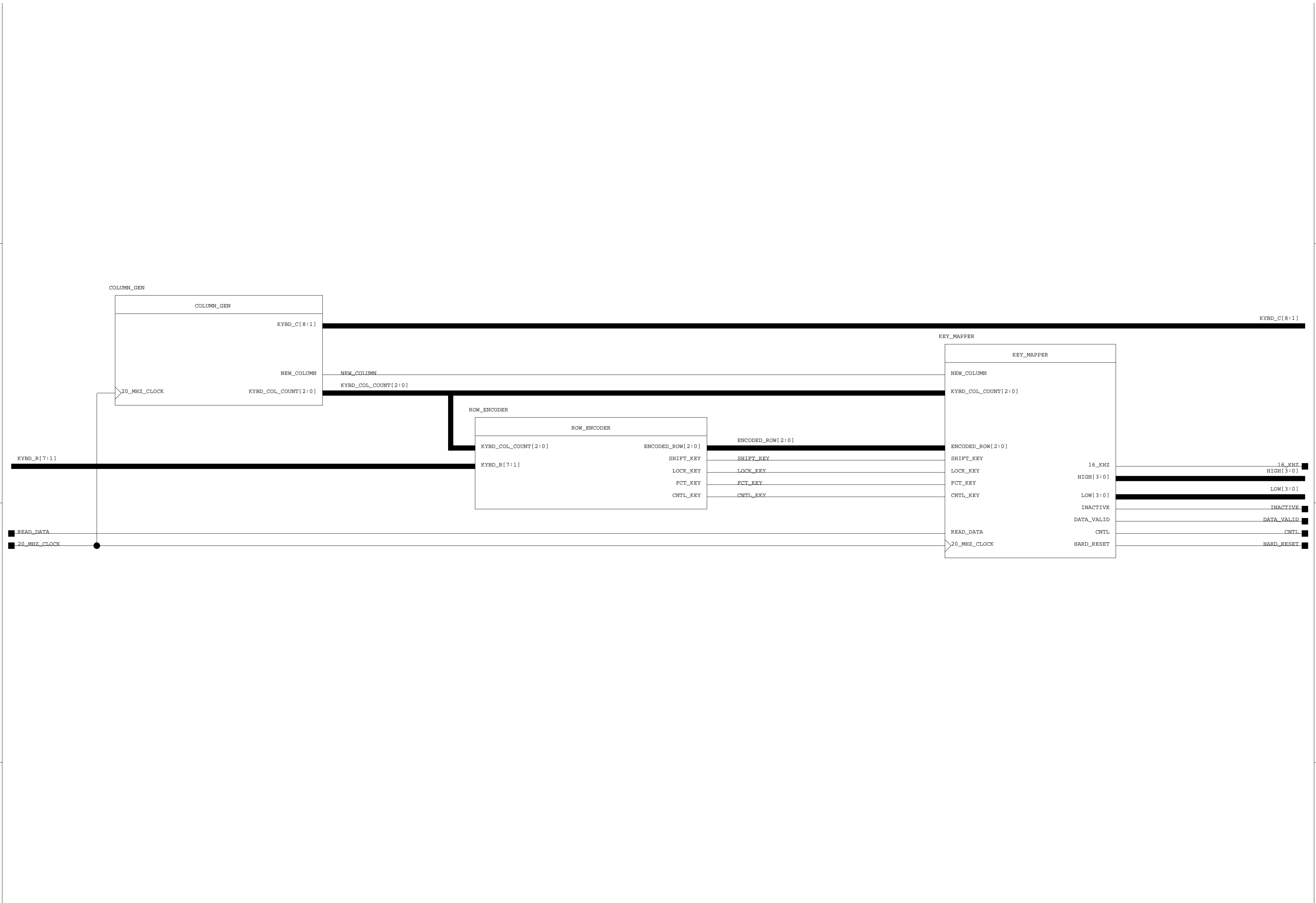

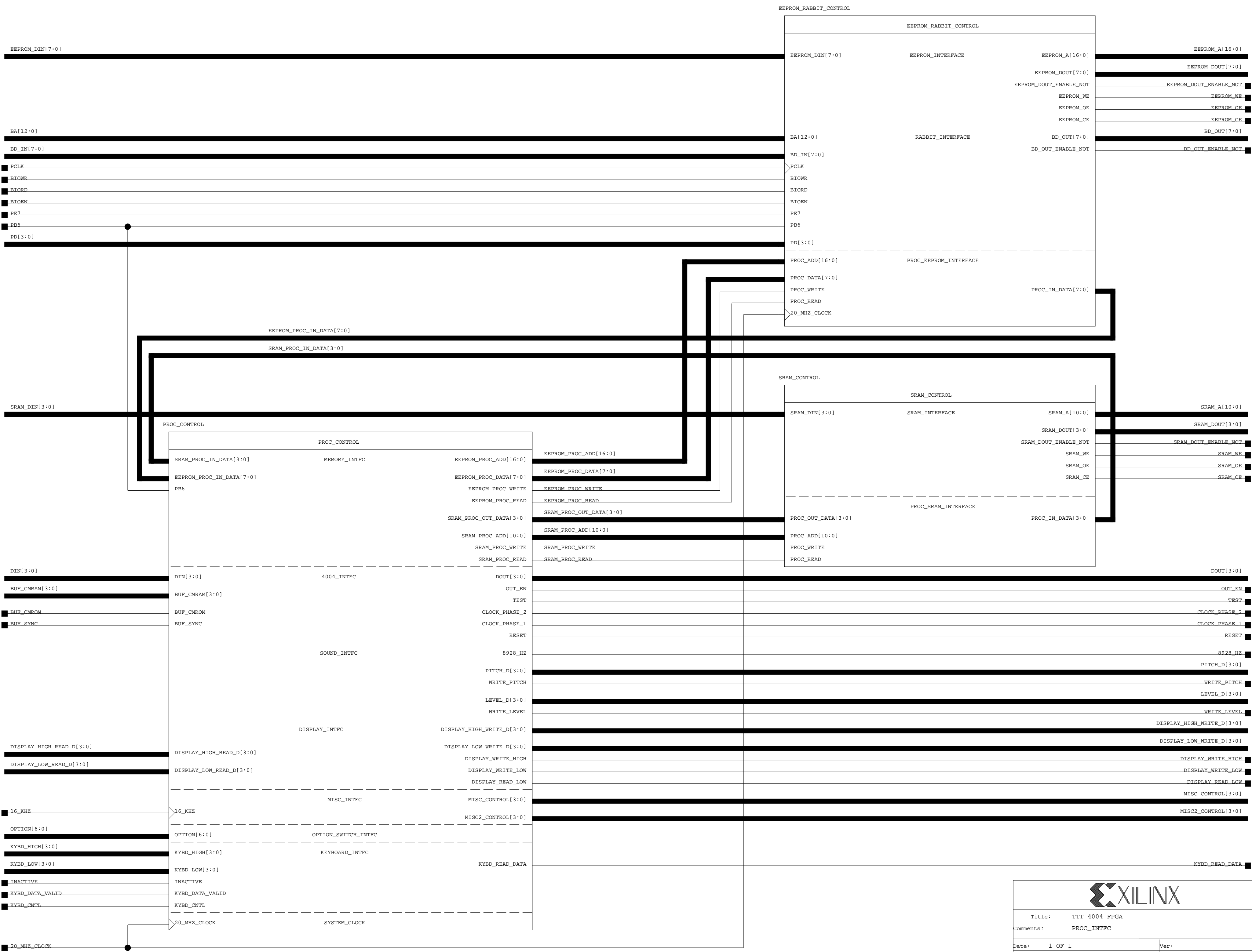

KYBD\_DIV\_DOWN\_COUNTER IS CHANGED FOR A LOWER DIVIDE DOWN RATIO FOR SIMULATION

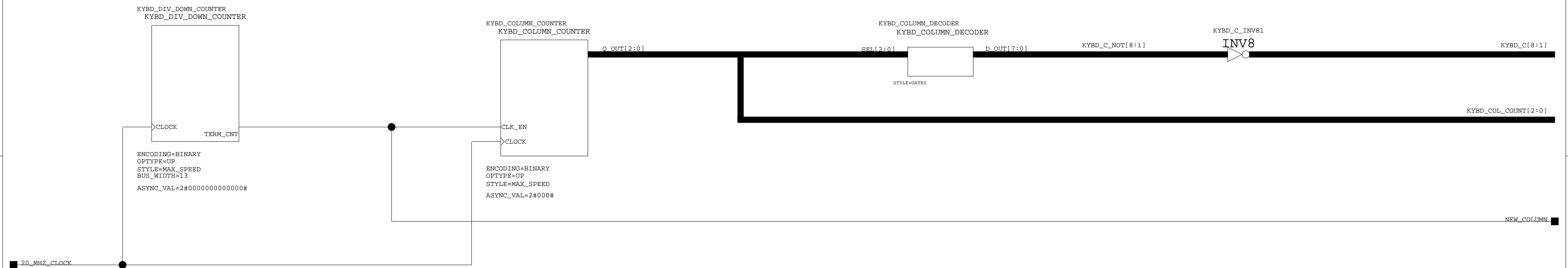

Title: TTT_4004_FPGA	
Comments: COLUMN_GEN	
Date: 1 OF 1	Ver:
Sheet Size: C	Rev:

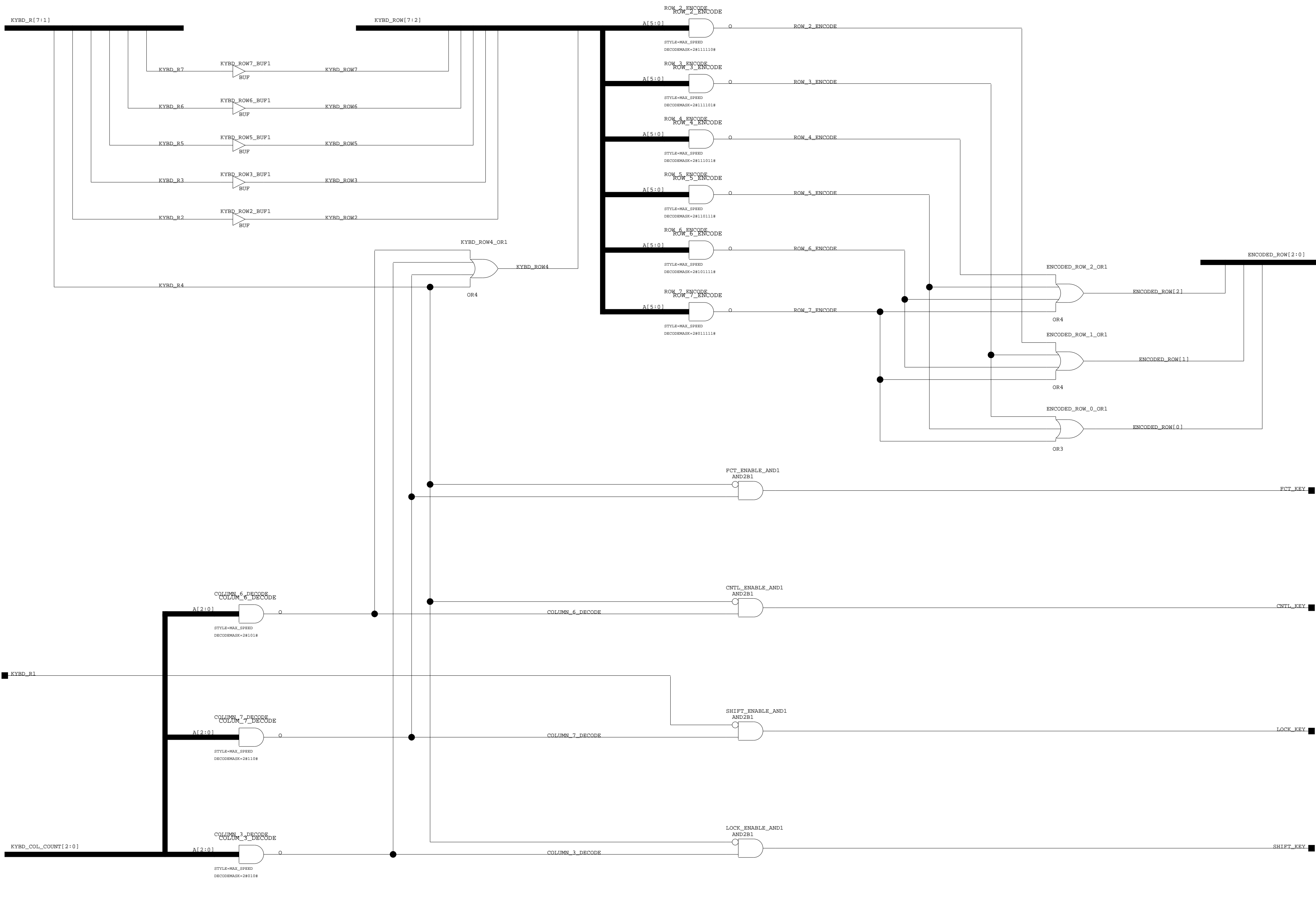

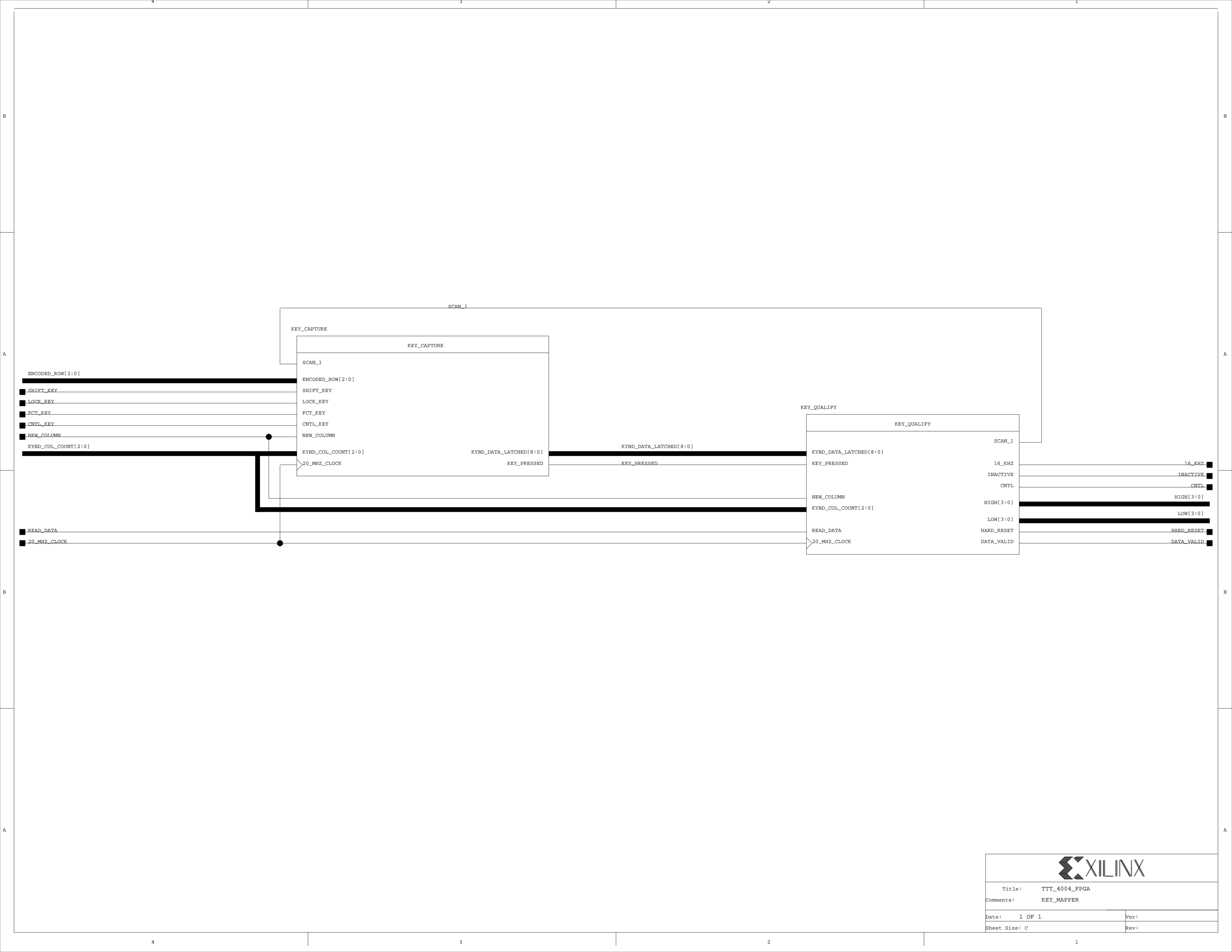

Title: TTT_4004_FPGA	
Comments: KEY_MAPPER	
Date: 1 OF 1	Ver:
Sheet Size: C	Rev:

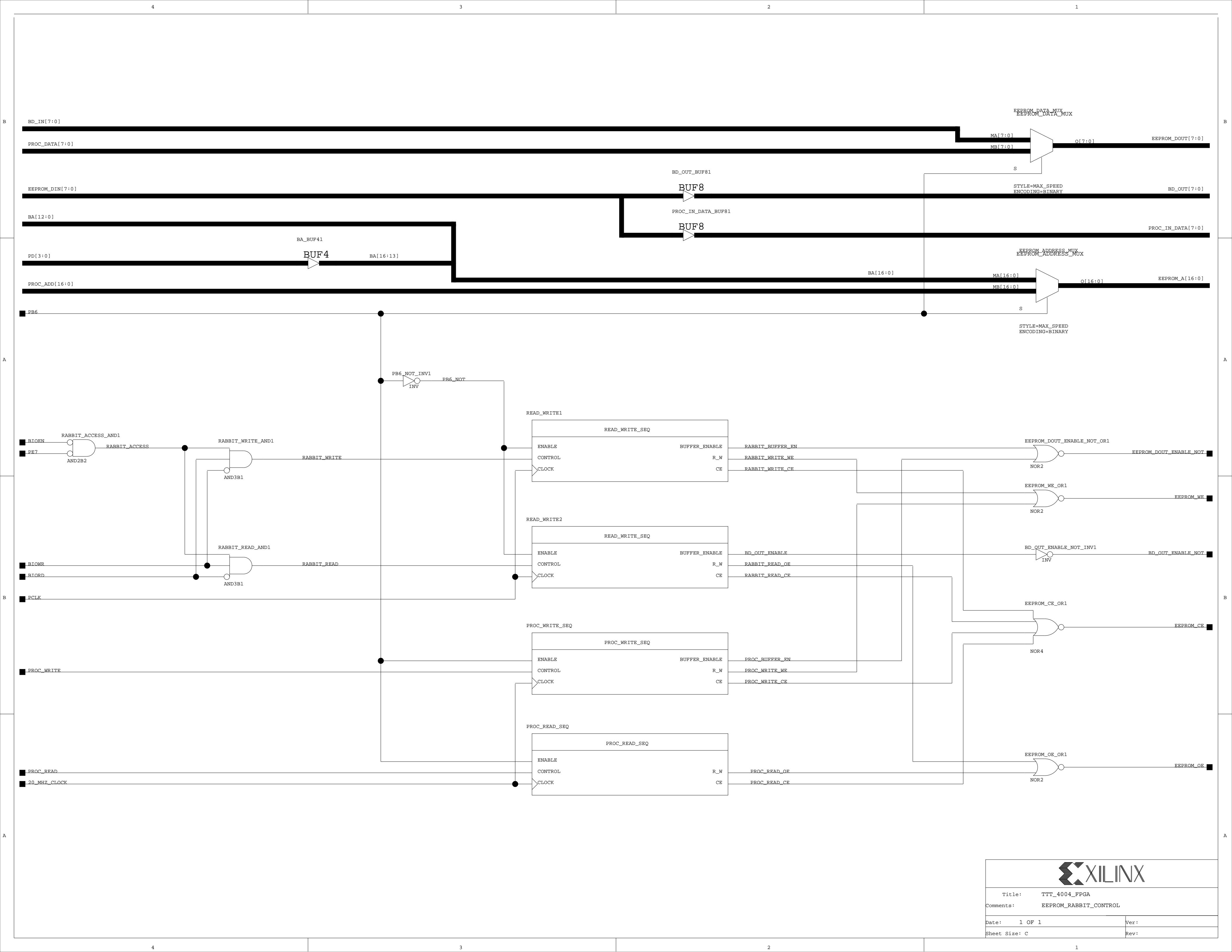

B

B



A

A

B

B

A

A



Title: TTI_4004_FPGA	
Comments: SRAM_CONTROL	
Date: 1 OF 1	Ver:
Sheet Size: C	Rev:

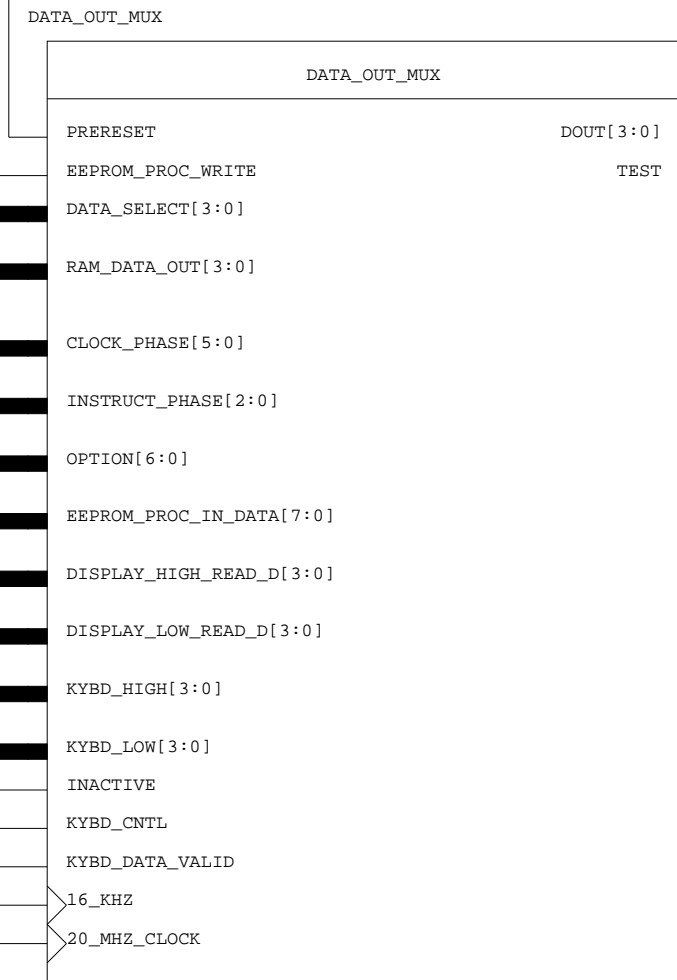
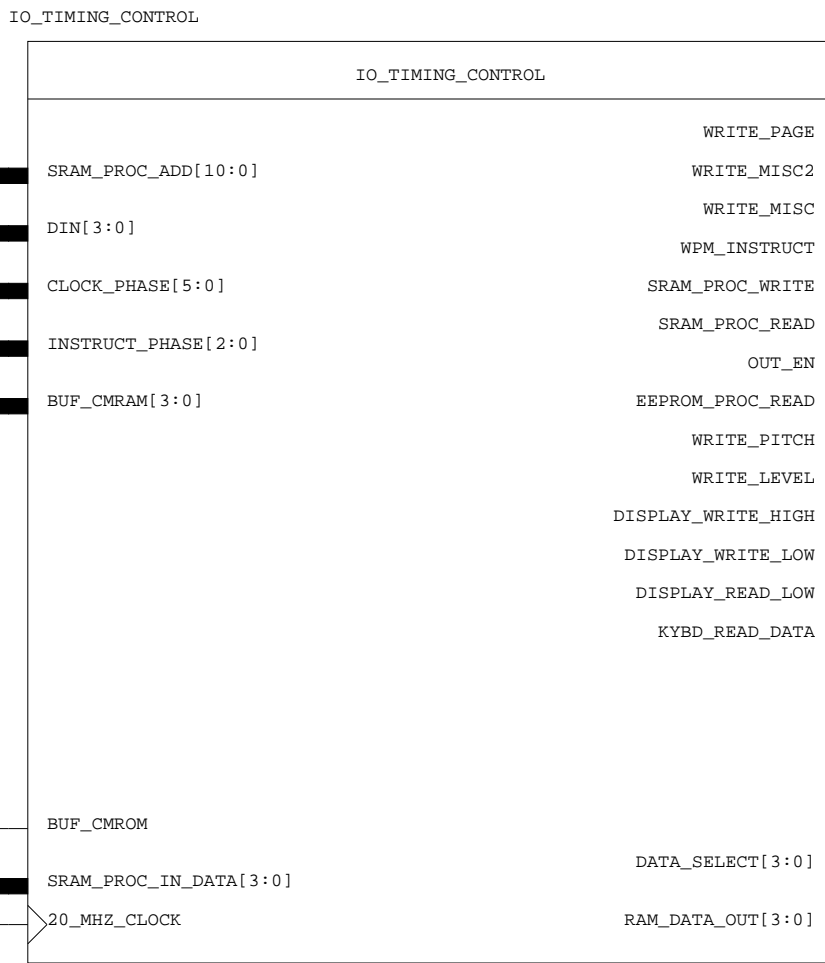
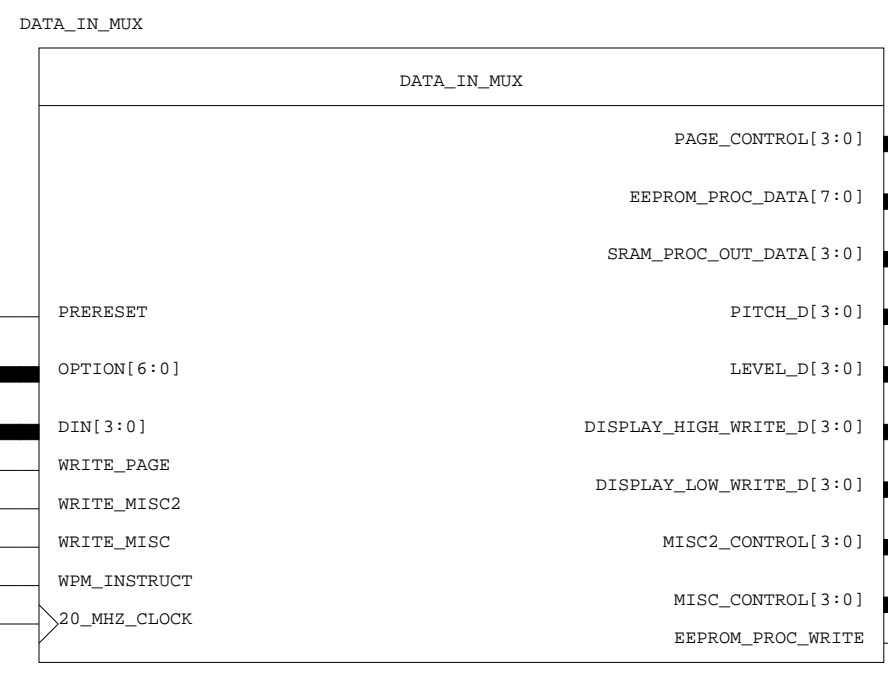
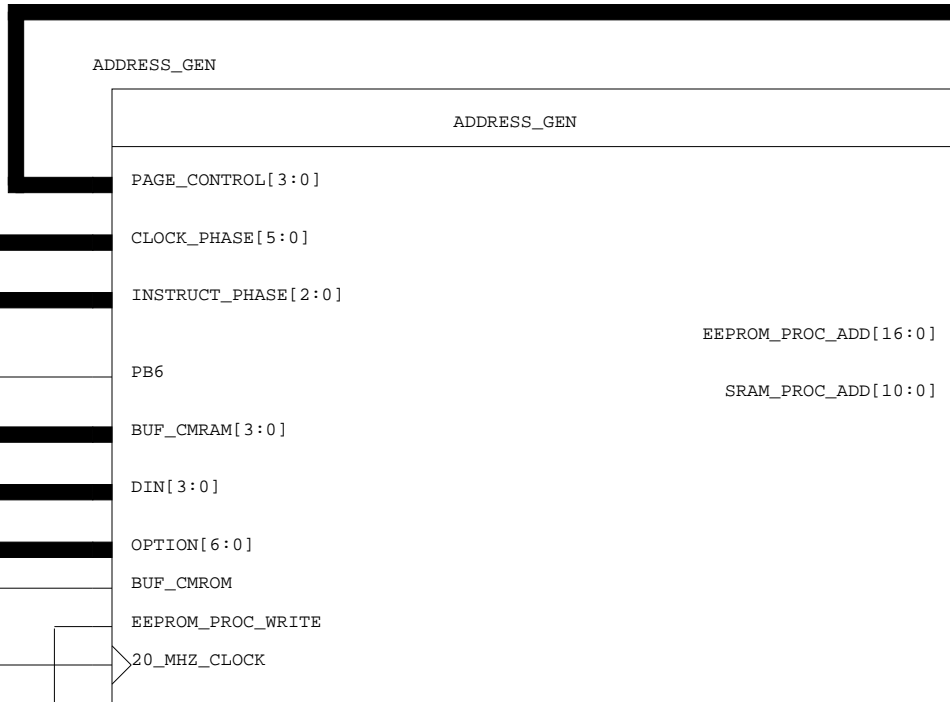
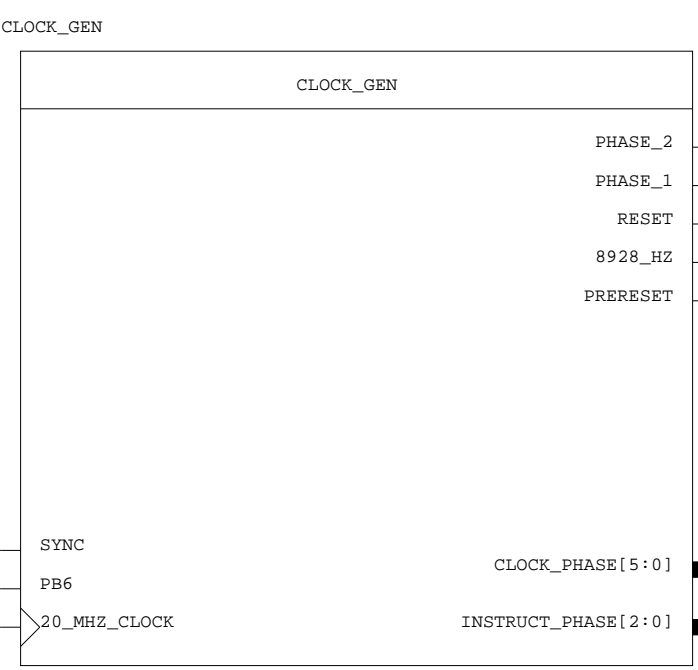
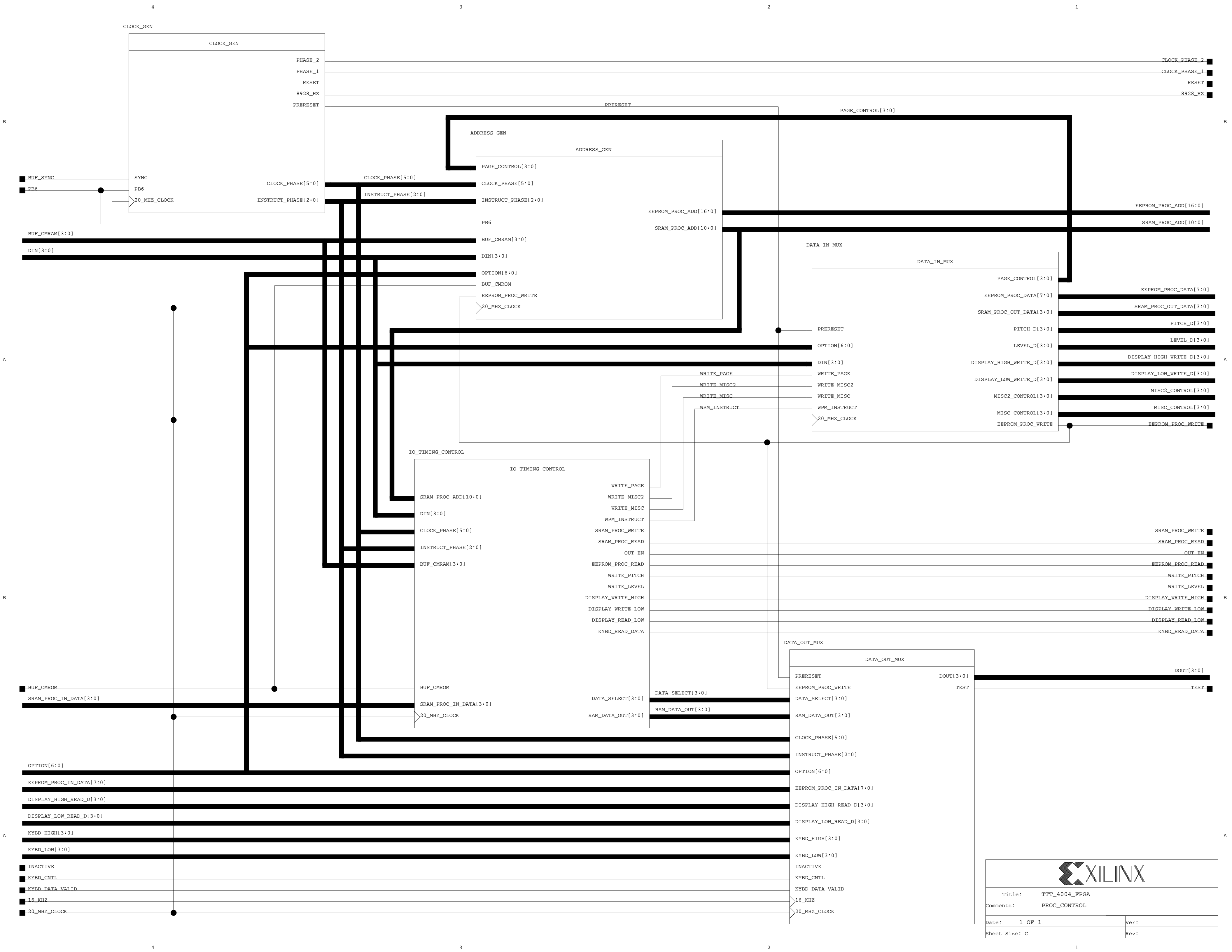

- BUF\_SYNC
- PB6
- BUF\_CM RAM[3:0]
- DIN[3:0]
- BUF\_CMROM
- SRAM\_PROC\_IN\_DATA[3:0]
- OPTION[6:0]
- EEPROM\_PROC\_IN\_DATA[7:0]
- DISPLAY\_HIGH\_READ\_D[3:0]
- DISPLAY\_LOW\_READ\_D[3:0]
- KYBD\_HIGH[3:0]
- KYBD\_LOW[3:0]
- INACTIVE
- KYBD\_CNTL
- KYBD\_DATA\_VALID
- 16\_KHZ
- 20\_MHZ\_CLOCK

- CLOCK\_PHASE\_2
- CLOCK\_PHASE\_1
- RESET
- 8928\_HZ
- EEPROM\_PROC\_ADD[16:0]
- SRAM\_PROC\_ADD[10:0]
- EEPROM\_PROC\_DATA[7:0]
- SRAM\_PROC\_OUT\_DATA[3:0]
- PITCH\_D[3:0]
- LEVEL\_D[3:0]
- DISPLAY\_HIGH\_WRITE\_D[3:0]
- DISPLAY\_LOW\_WRITE\_D[3:0]
- MISC2\_CONTROL[3:0]
- MISC\_CONTROL[3:0]
- EEPROM\_PROC\_WRITE
- SRAM\_PROC\_WRITE
- SRAM\_PROC\_READ
- OUT\_EN
- EEPROM\_PROC\_READ
- WRITE\_PITCH
- WRITE\_LEVEL
- DISPLAY\_WRITE\_HIGH
- DISPLAY\_WRITE\_LOW
- DISPLAY\_READ\_LOW
- KYBD\_READ\_DATA
- DO UT[3:0]
- TEST



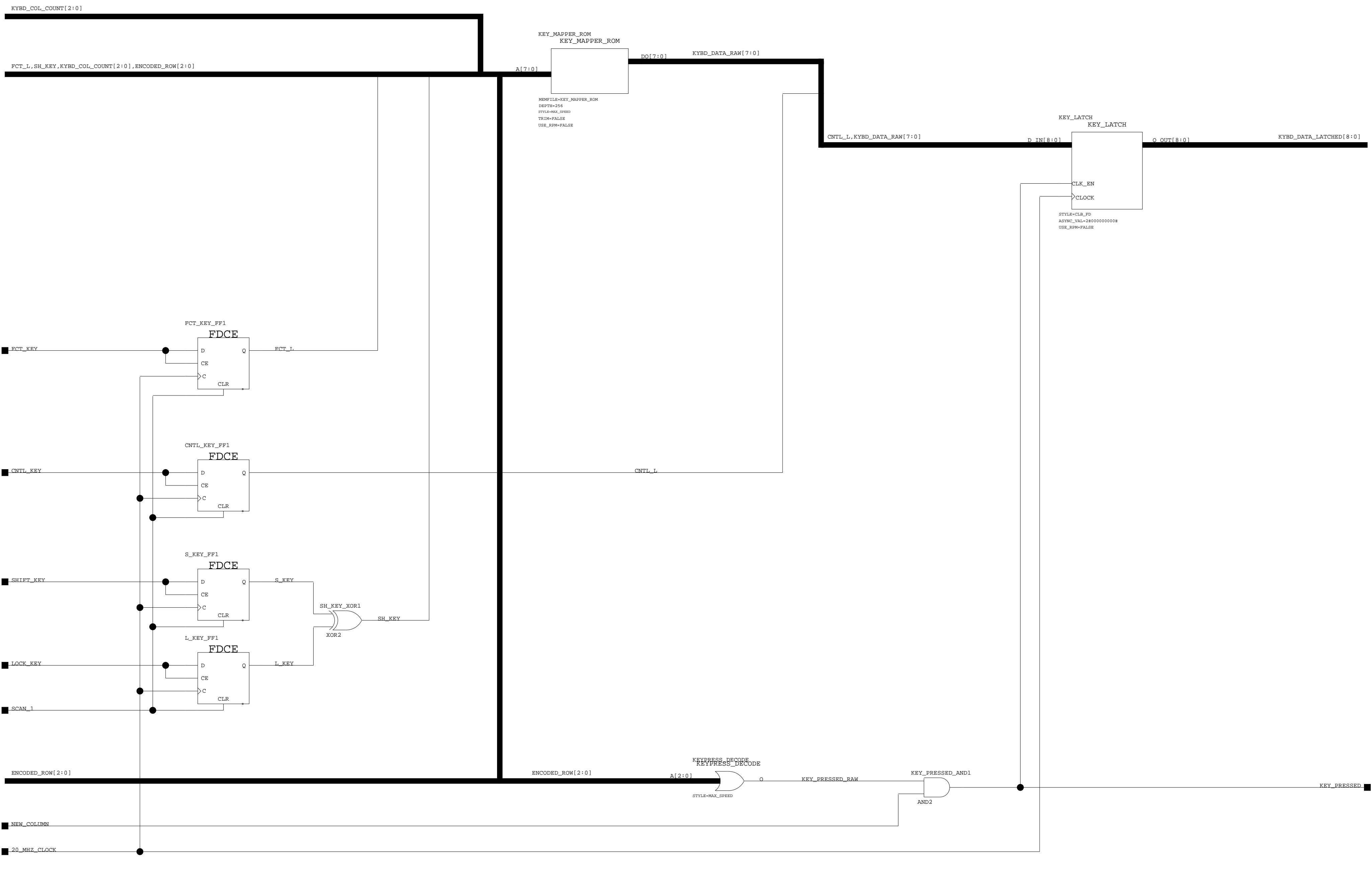
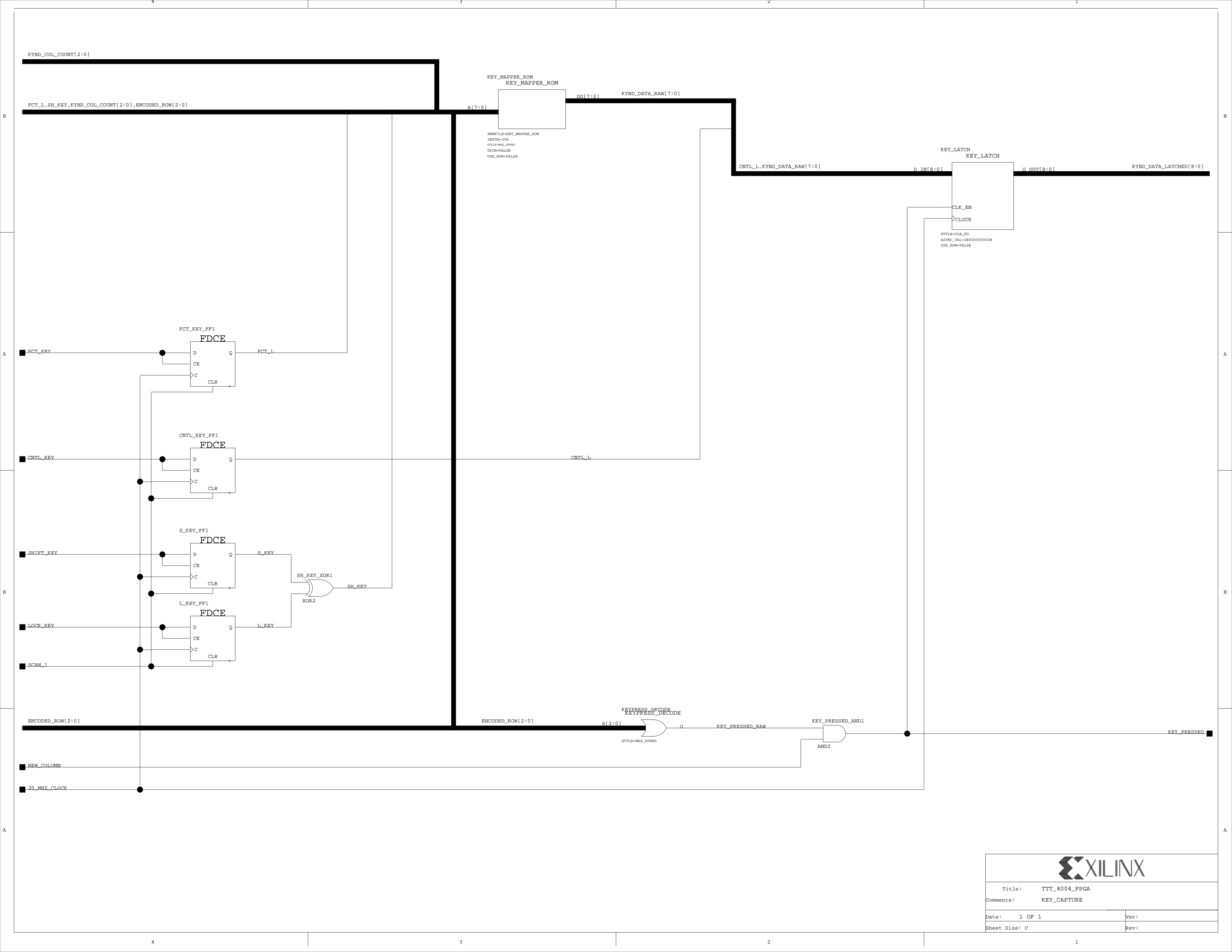

Title: TTT_4004_FPGA	
Comments: KEY_CAPTURE	
Date: 1 OF 1	Ver:
Sheet Size: C	Rev:



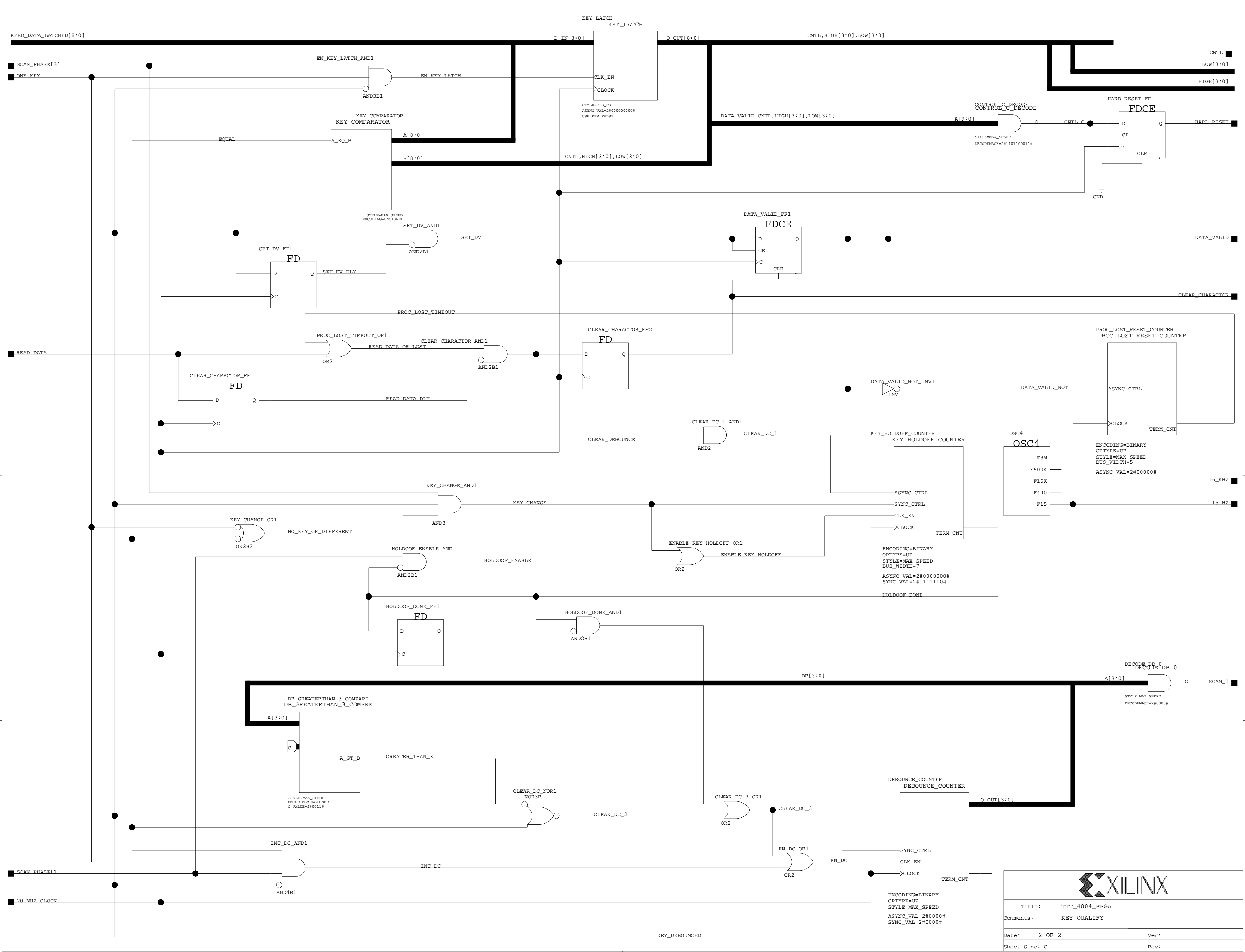

B

B

A

A

B

B

A

A

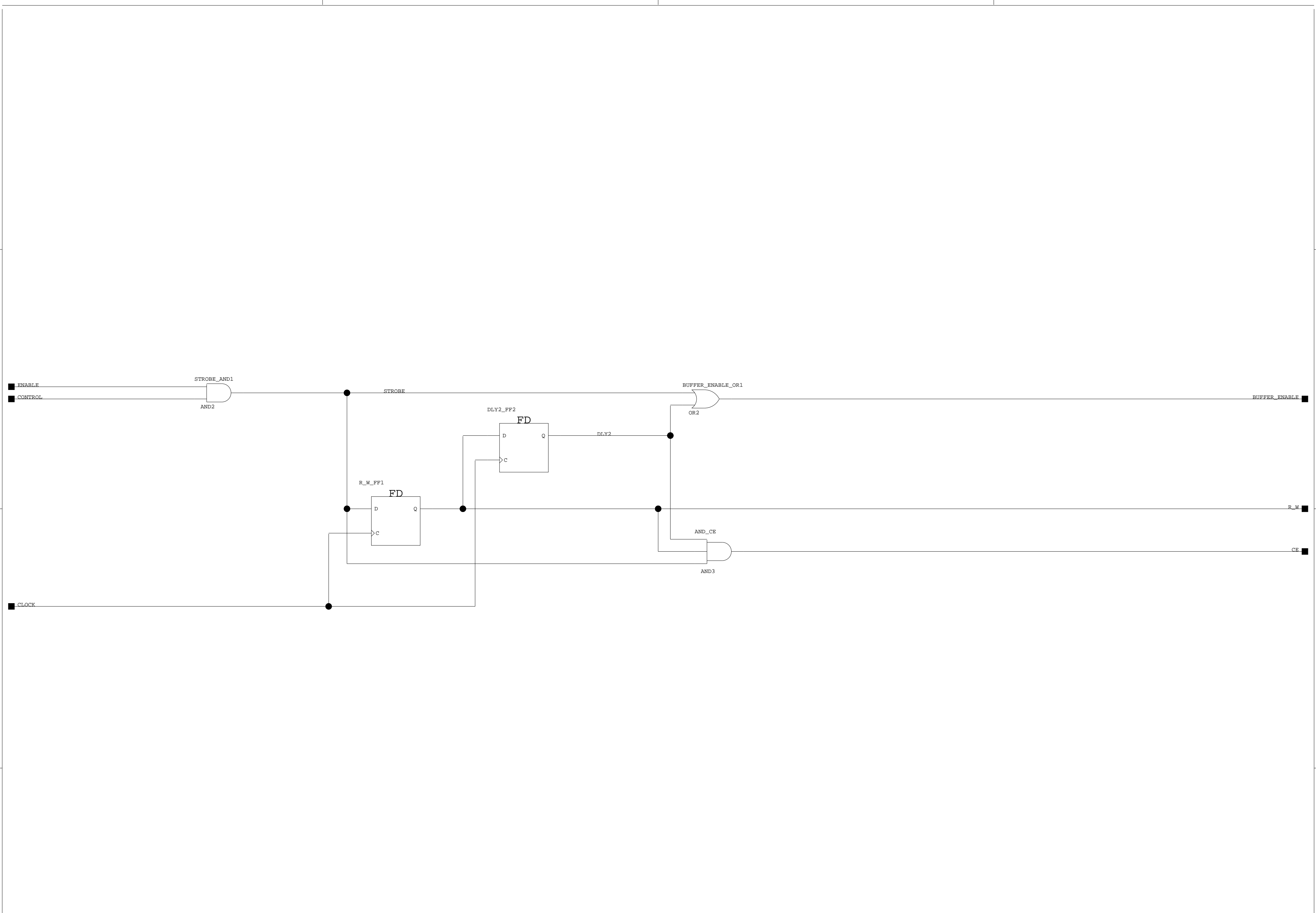

Title: TTI_4004_FPGA	
Comments: read_write_seq	
Date: 1 OF 1	Ver:
Sheet Size: C	Rev:

B

B

A

A

B

B

A

A

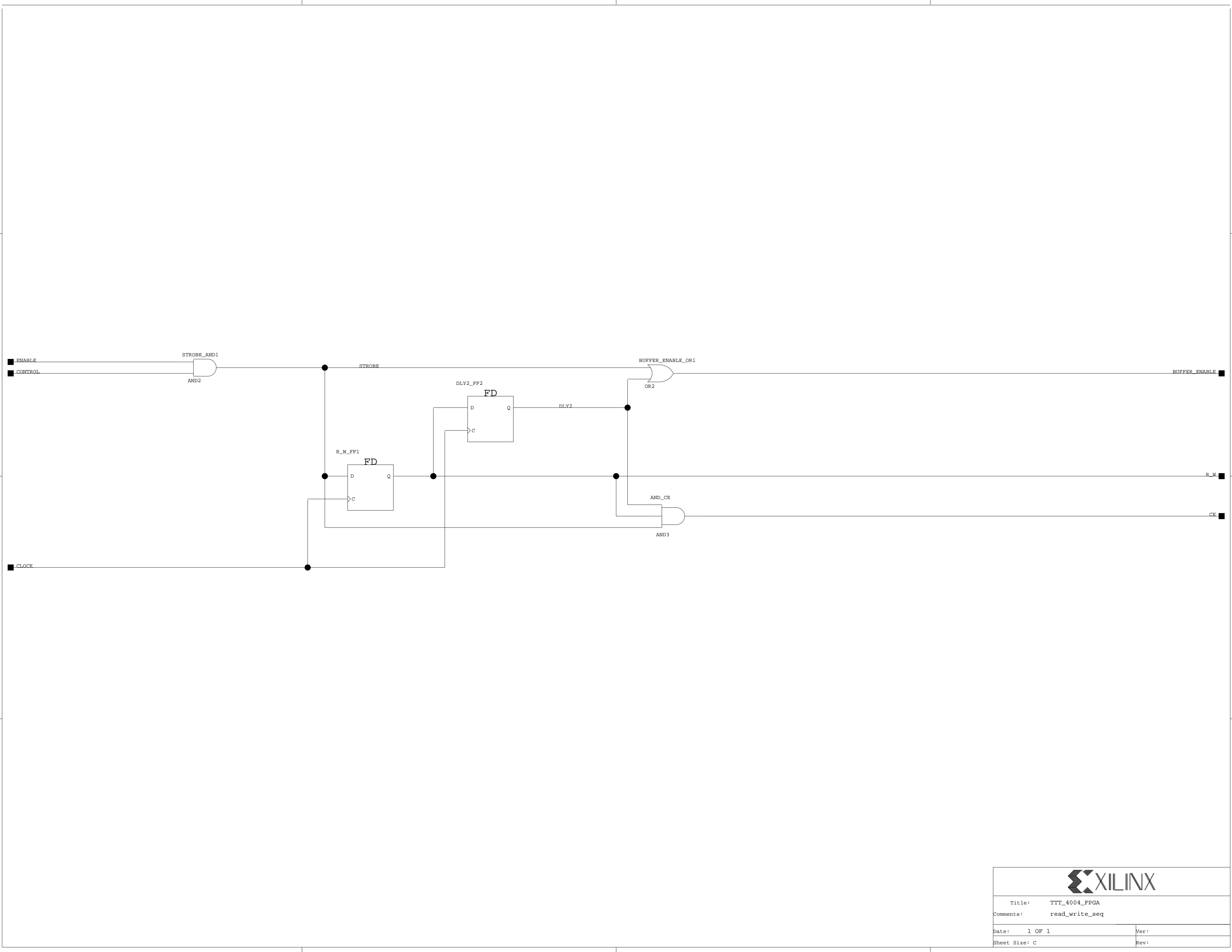

Title: TTI_4004_FPGA	
Comments: read_write_seq	
Date: 1 OF 1	Ver:
Sheet Size: C	Rev:

B

B

A

A

B

B

A

A

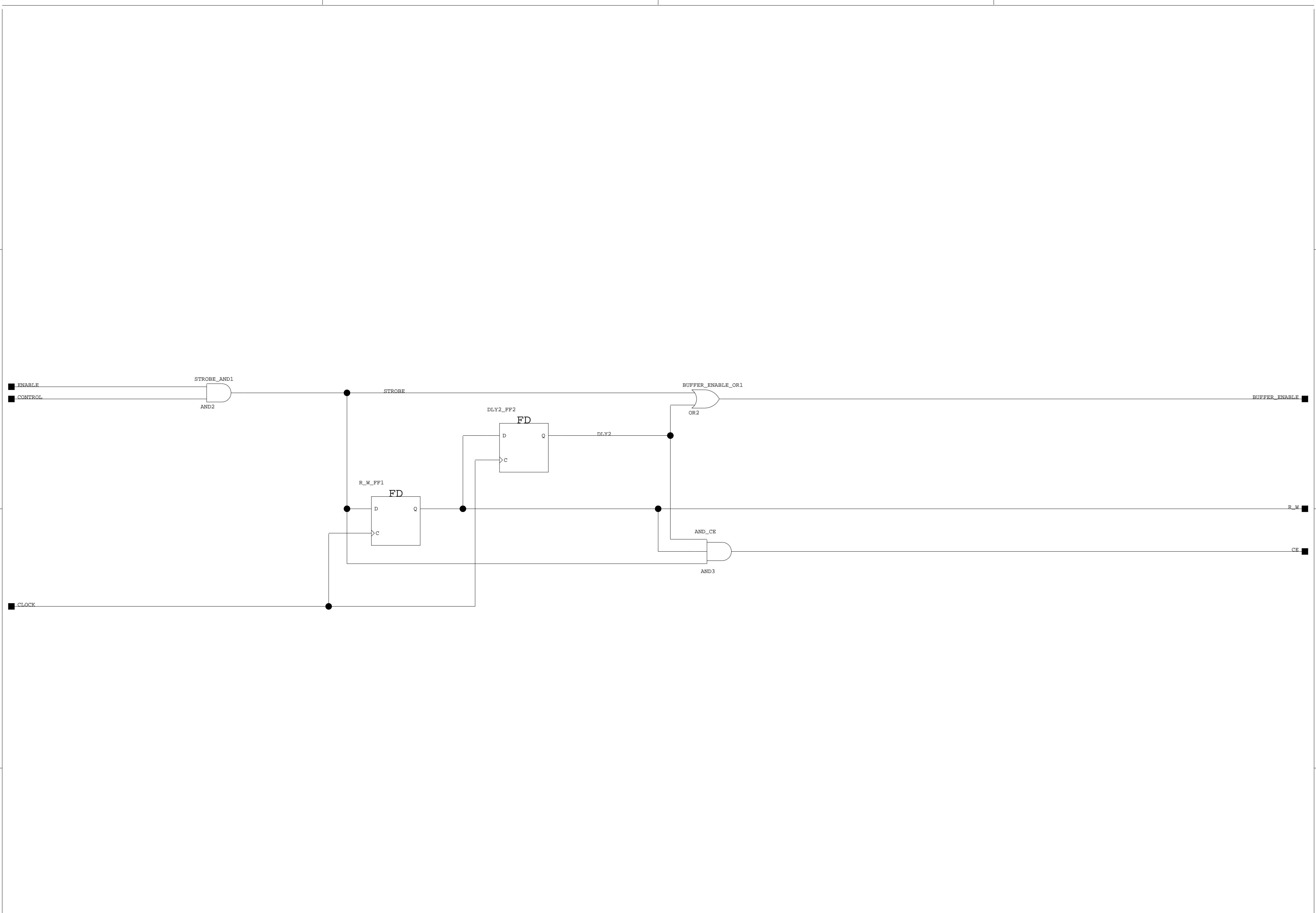

Title: TTI_4004_FPGA	
Comments: read_write_seq	
Date: 1 OF 1	Ver:
Sheet Size: C	Rev:

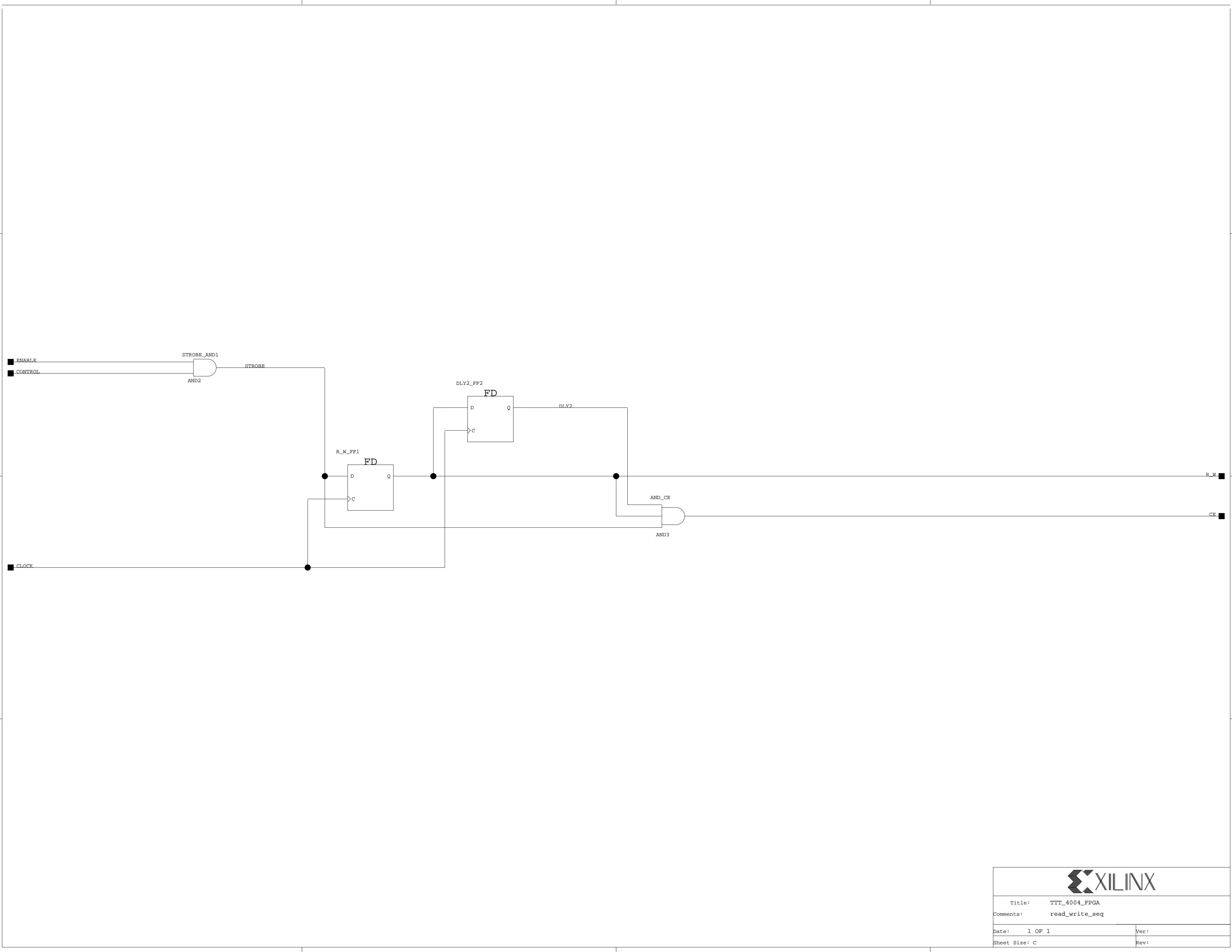

Title: TTI_4004_FPGA	
Comments: read_write_seq	
Date: 1 OF 1	Ver:
Sheet Size: C	Rev:

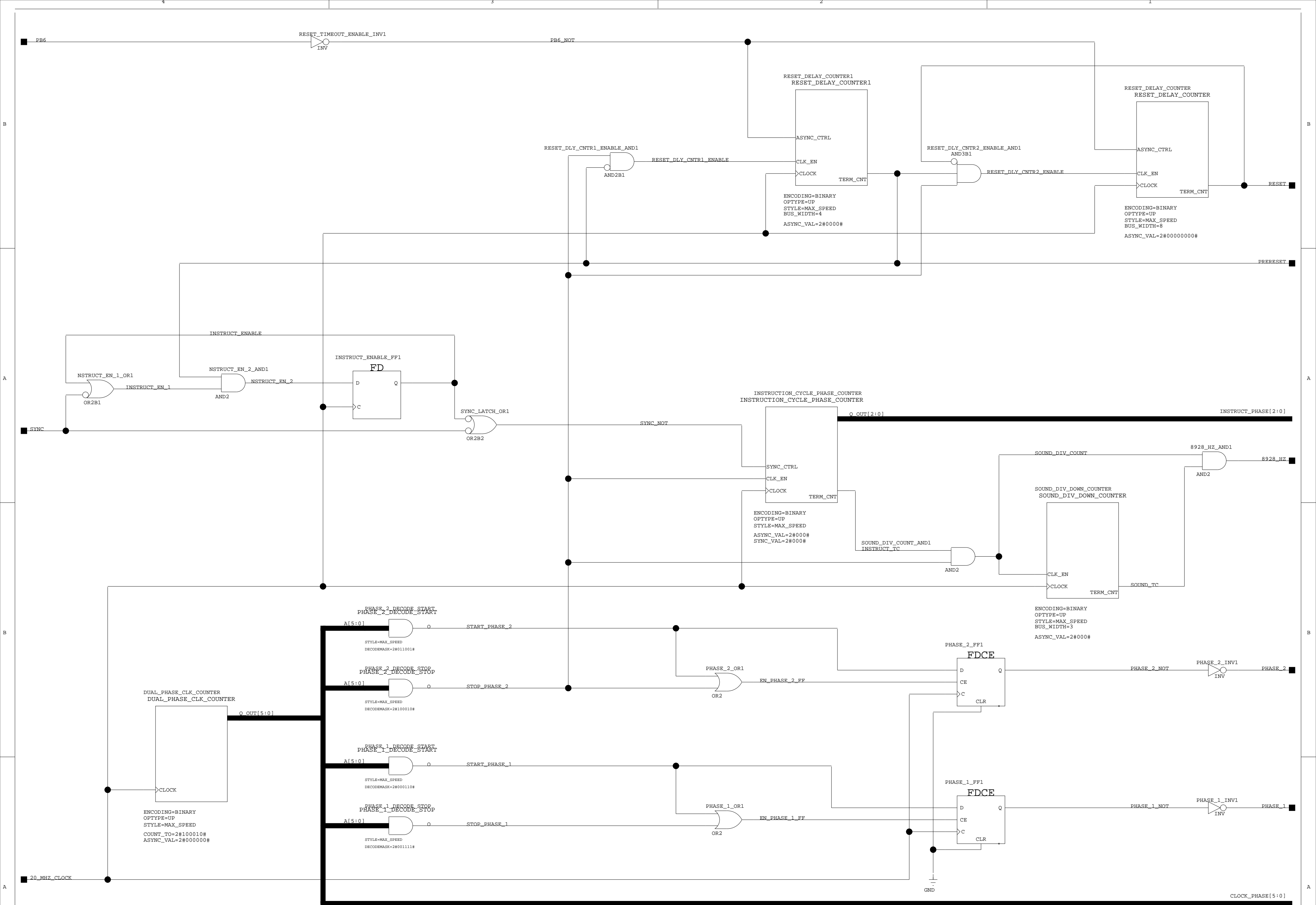

Title: TTT_4004_FPGA	
Comments: CLOCK_GEN	
Date: 1 OF 1	Ver:
Sheet Size: C	Rev:

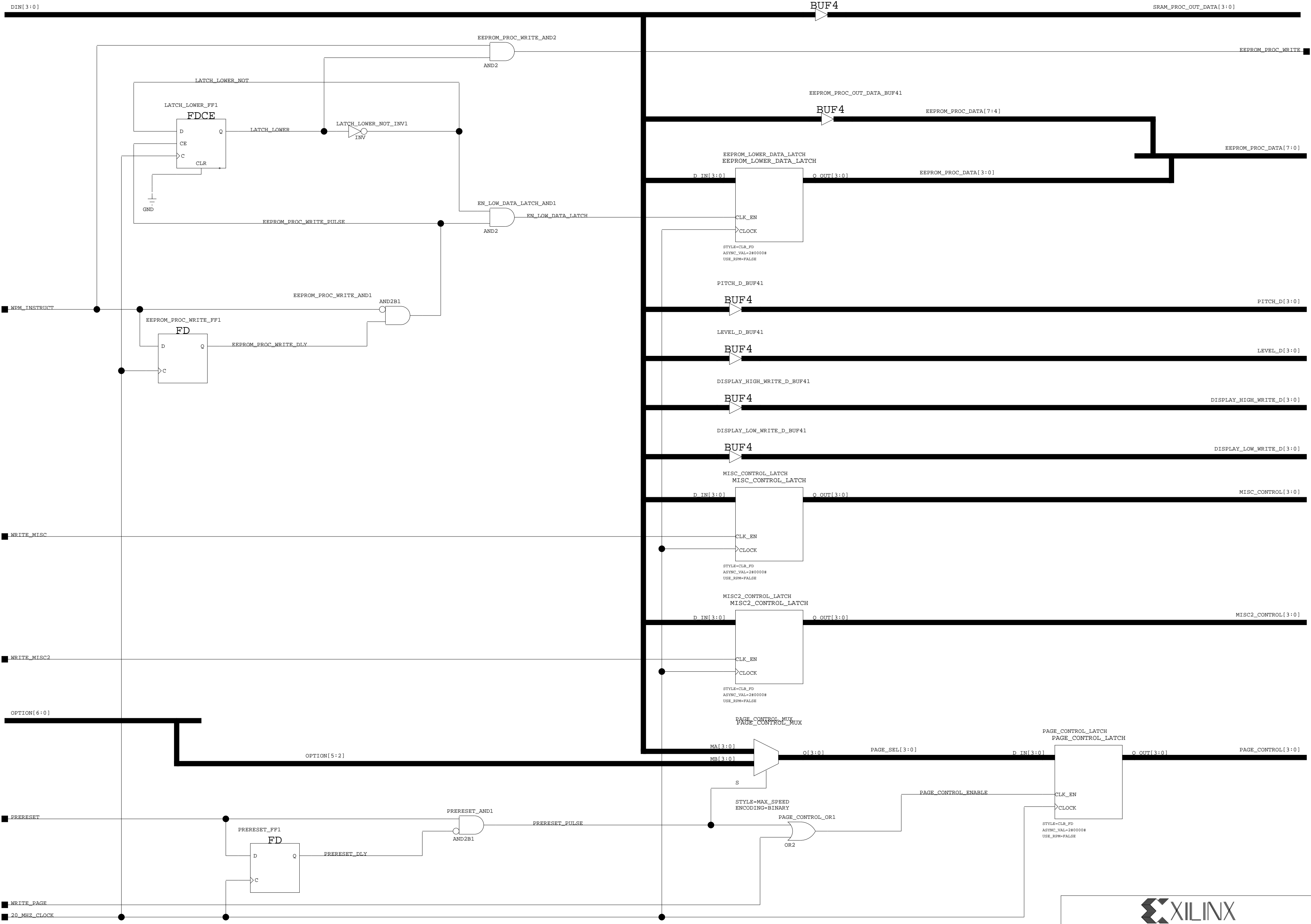



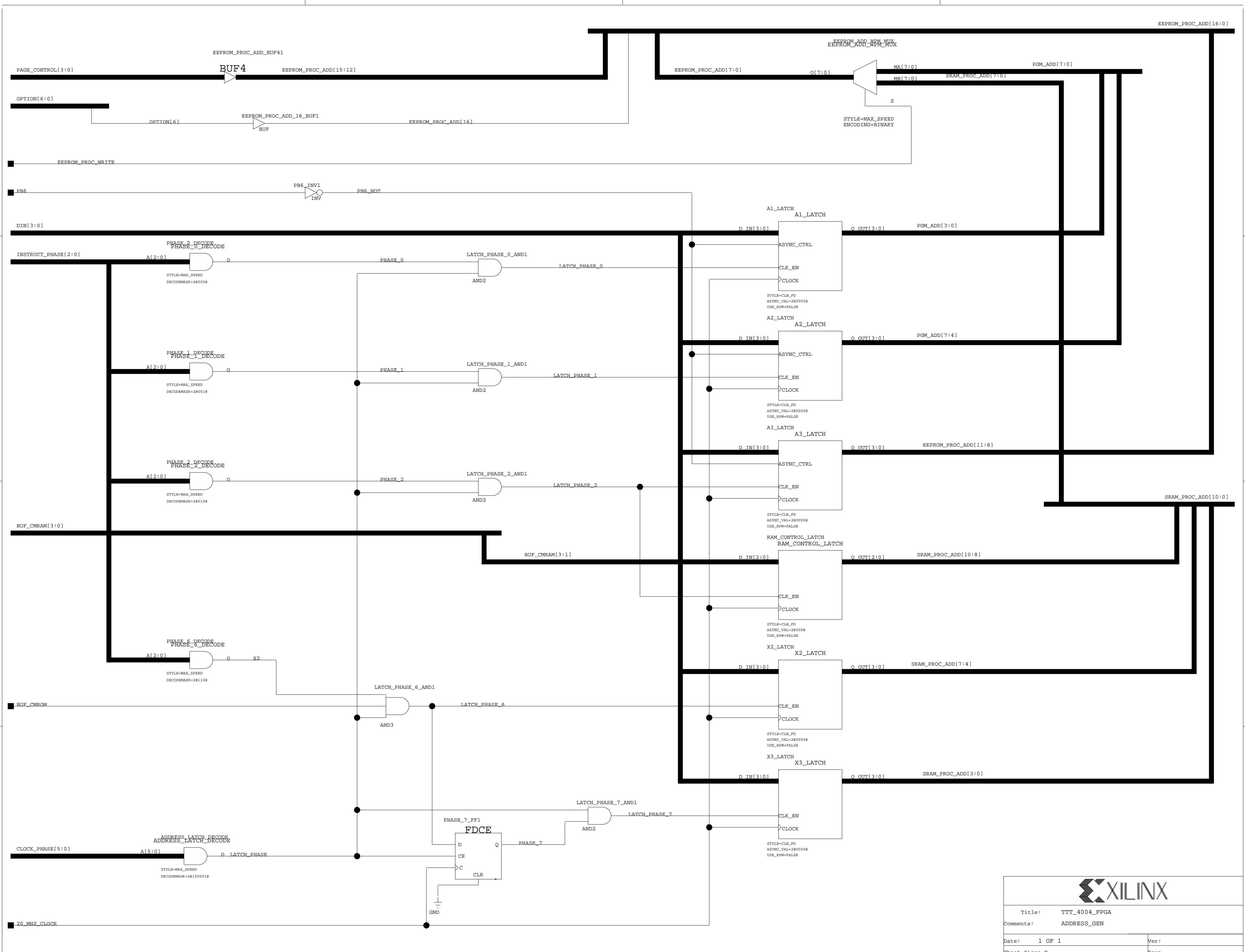

Title: TTT_4004_FPGA	
Comments: ADDRESS_GEN	
Date: 1 OF 1	Ver:
Sheet Size: C	Rev:

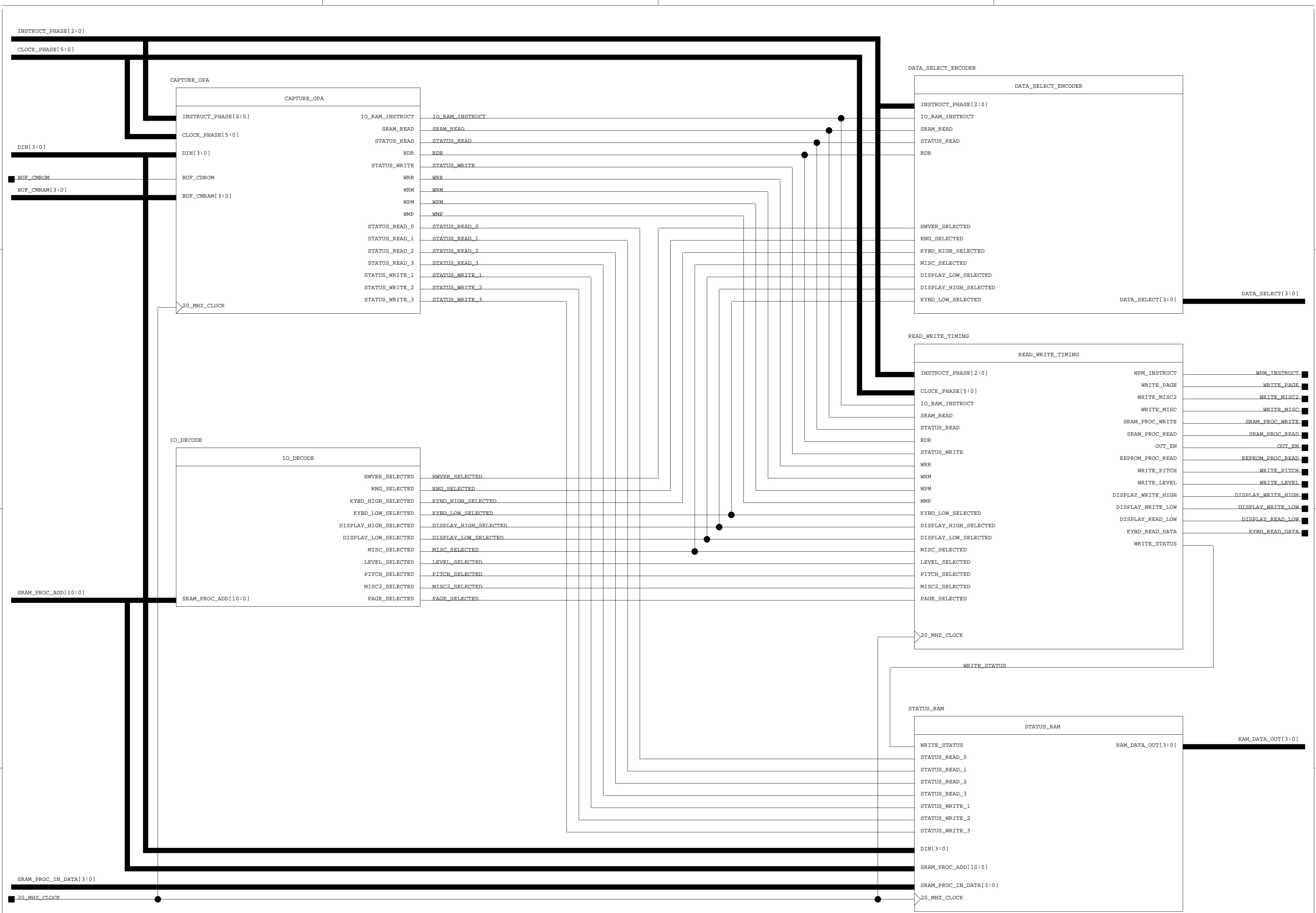

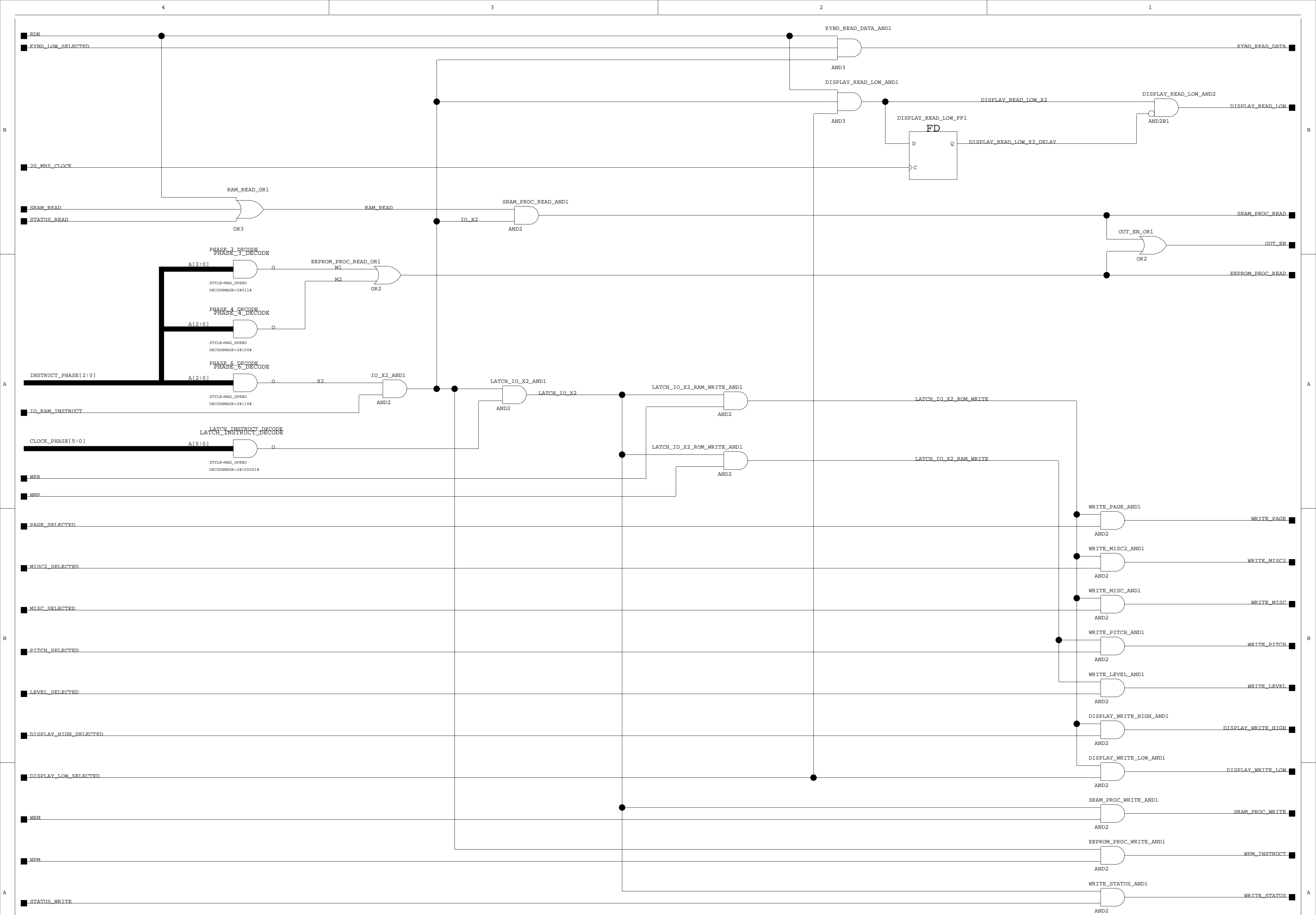

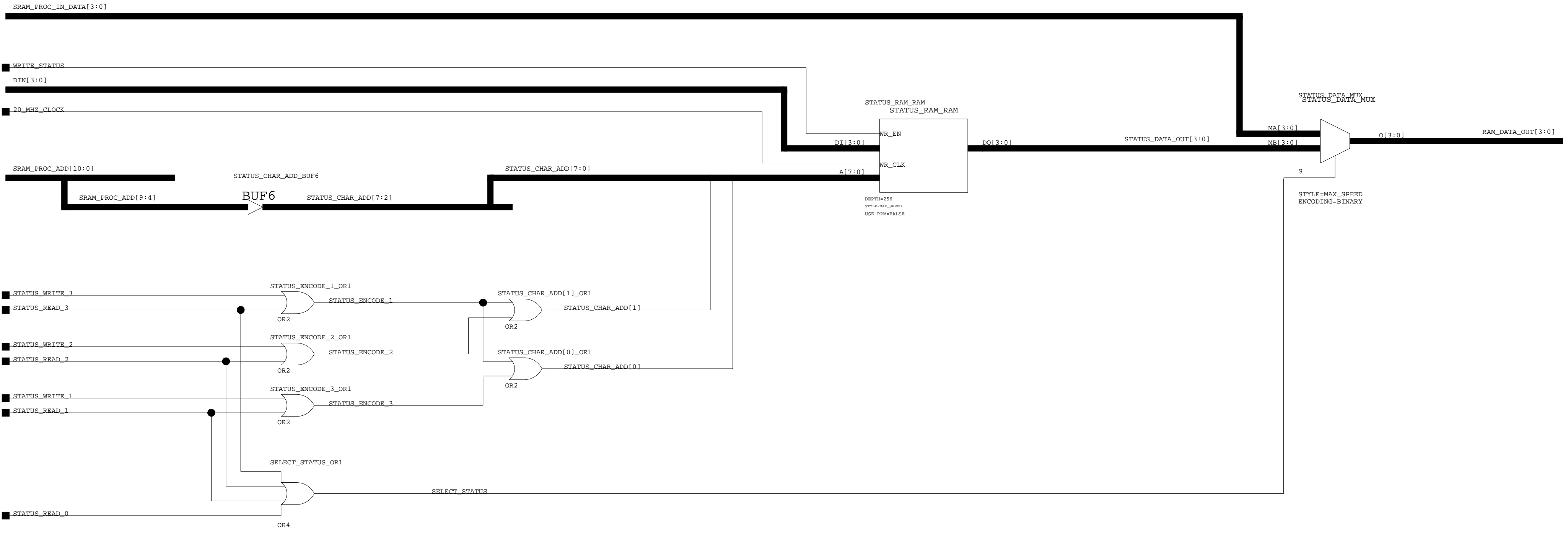

SRAM\_PROC\_ADD[10:0]

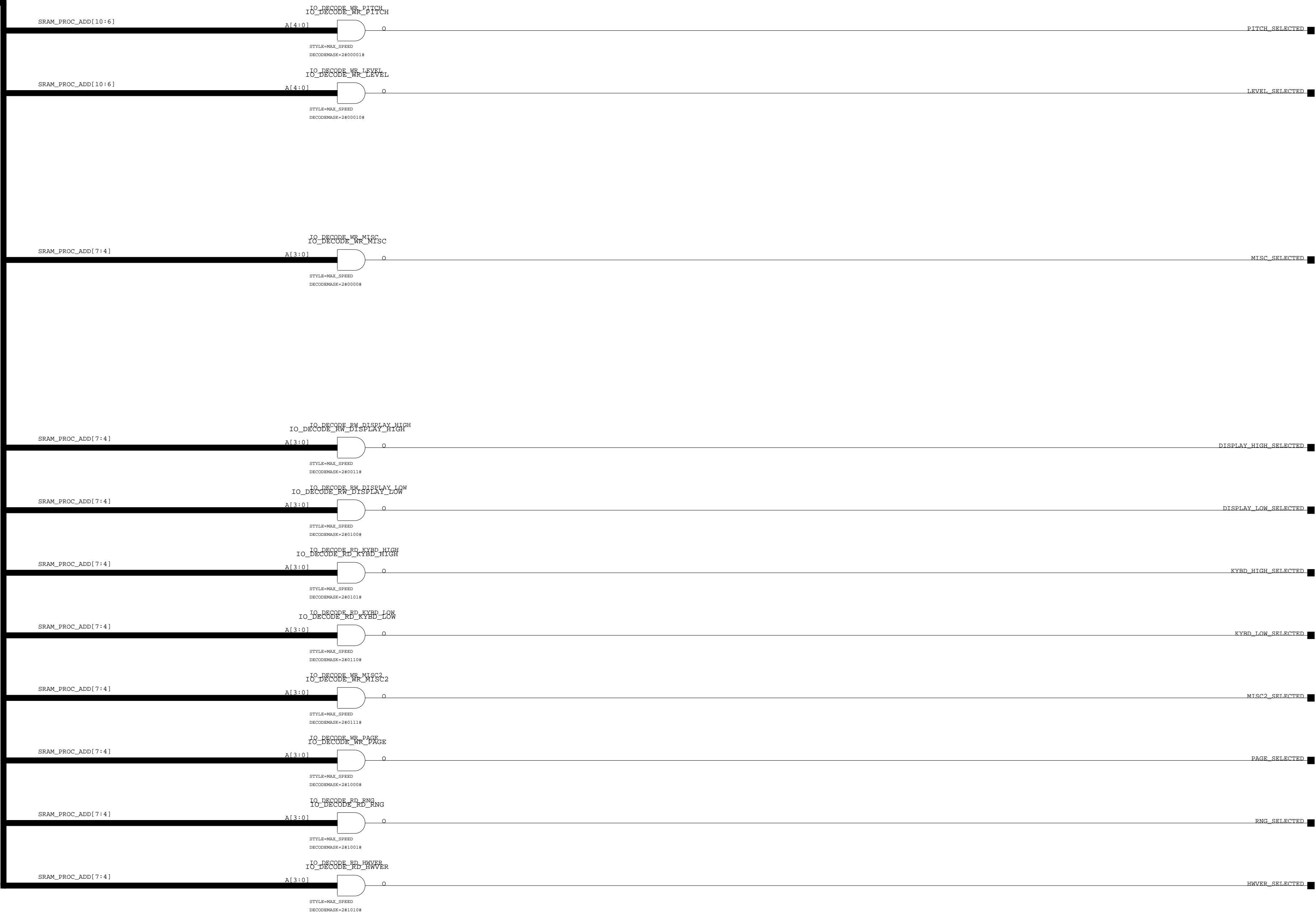

Title: TTI_4004_FPGA	
Comments: IO_DECODE	
Date: 1 OF 1	Ver:
Sheet Size: C	Rev:

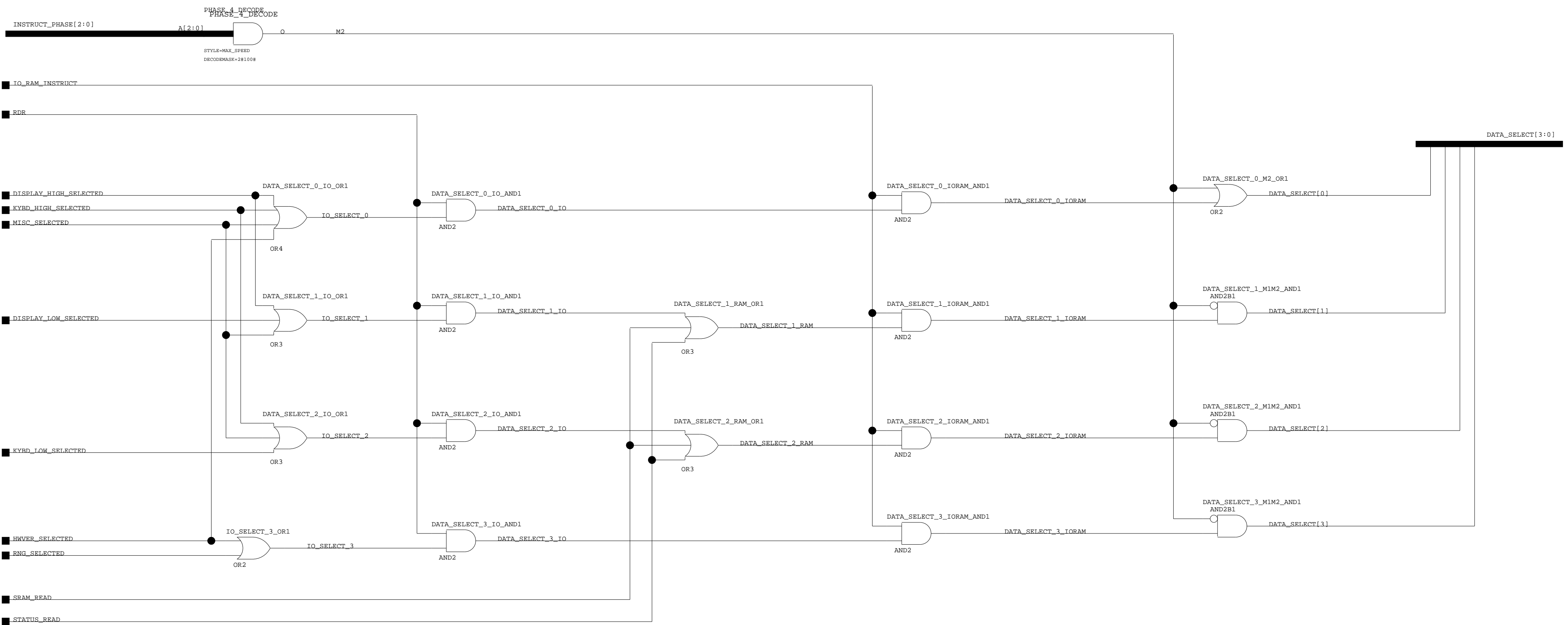

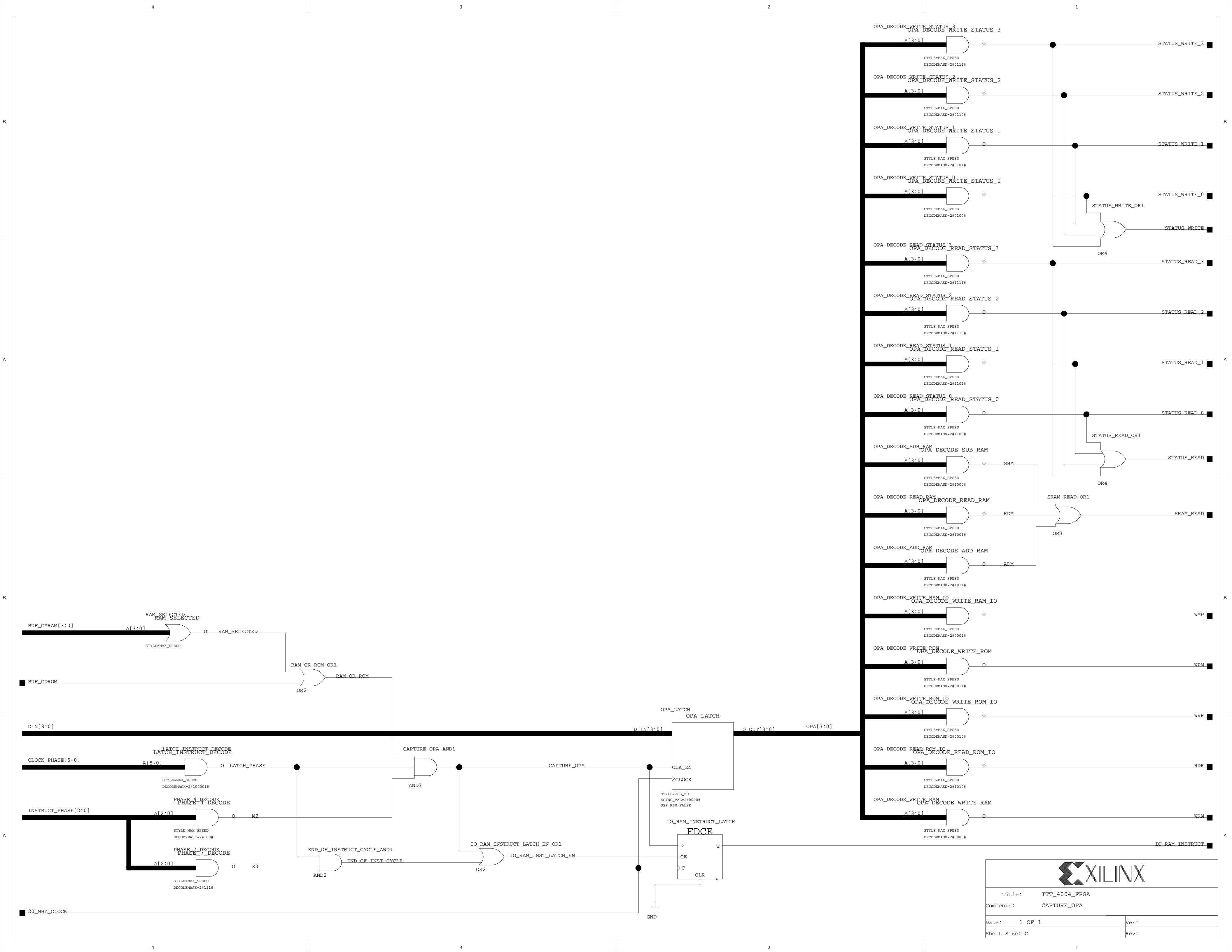

Title: TTI_4004_FPGA	
Comments: CAPTURE_OPA	
Date: 1 OF 1	Ver:
Sheet Size: C	Rev: